

'23

*Culex pipiens pipiens*  
*Aedes albopictus*  
*Chironomus*  
*Larus marinus*  
*Musca domestica*  
*Columba livia*  
*Ephestia*  
*Dermestes lardarius*  
*Myioblastus*  
*Myioblastus*



# PRODUCT CATEGORY INDEX

## BIRD CONTROL

● ANTI-PERCHING SYSTEMS	6
● ACCESSORIES	19
● ELECTRIC LINE	24
● ANTI-INTRUSION SYSTEMS	38
● ACCESSORIES	48
● SOUND SCARE SYSTEMS	60
● VISUAL DETERRENTS	62
● CATCH TRAPS	63
● TOOLS	66

## RODENT CONTROL

● BAIT STATIONS	72
● CATCH TRAPS	95
● ACCESSORIES	112
● CUSTOMISATION	123

## INSECT CONTROL

● 4INSECTS RANGE	128
● FLY CUT	131
● TRAPS	132
● BAIT STATIONS	137



### O.S.D. Group S.r.l.

Via Ponte Alto, 10  
41011 Campogalliano  
Modena  
Italy

Phone +39 059 526595  
+39 059 528288

Fax +39 059 527867

Web site [www.osdgroup.eu](http://www.osdgroup.eu)

### Contacts

Technical Manager [tecnico@osdgroup.it](mailto:tecnico@osdgroup.it)

Italian Market Sales Manager [daniela@osdgroup.it](mailto:daniela@osdgroup.it)

Export Sales Manager [enrica@osdgroup.it](mailto:enrica@osdgroup.it)

General contact / Orders [sales@osdgroup.it](mailto:sales@osdgroup.it)

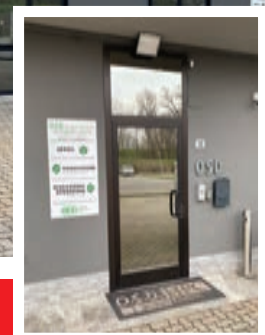

Follow  
us on



LinkedIn

**ECO** **BIRDS**®



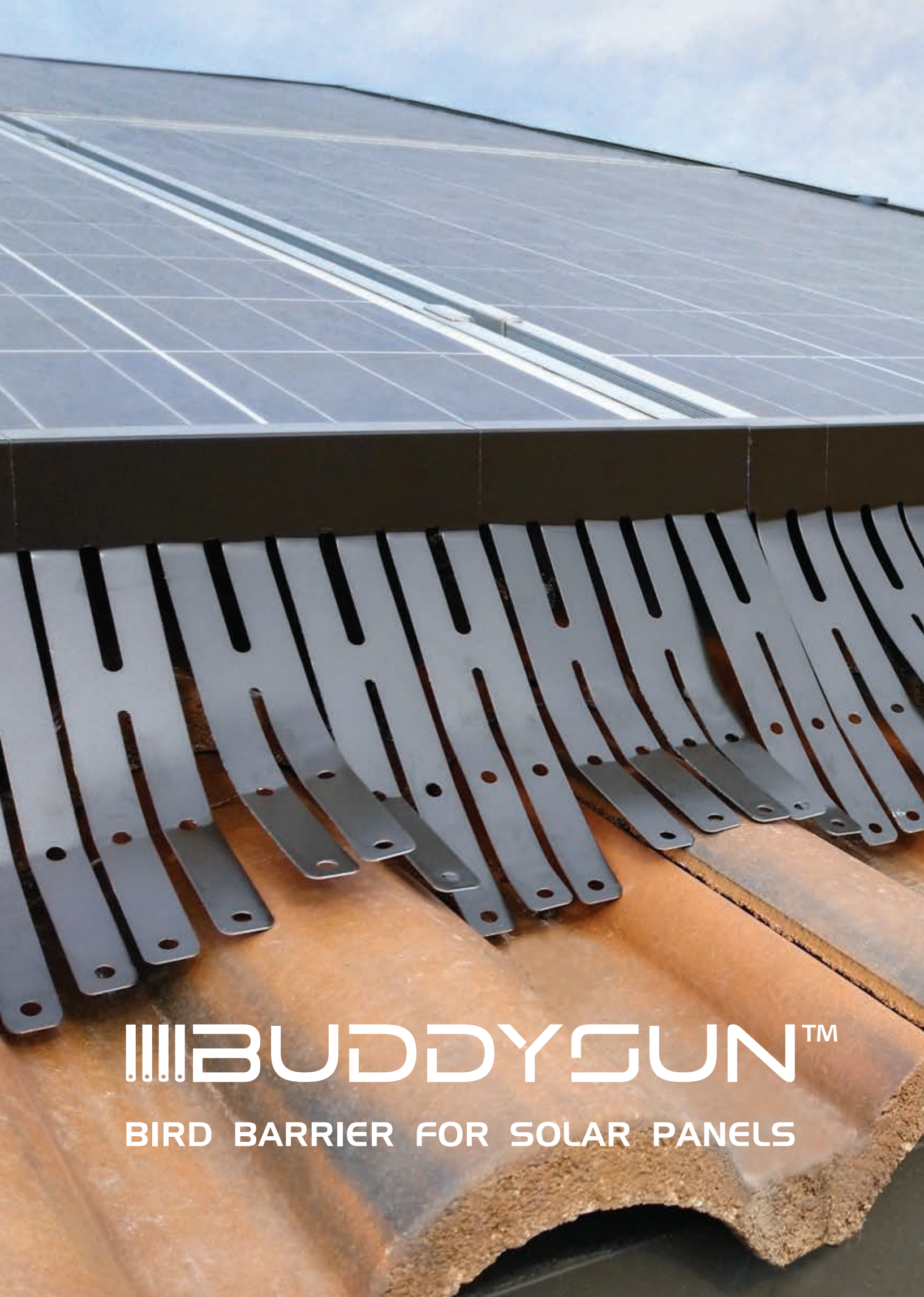

**BUDDYGUN™**

**BIRD BARRIER FOR SOLAR PANELS**



# BIRD CONTROL

## ANTI-PERCHING SYSTEMS

POLYCARBONATE + STEEL 6

POLYCARBONATE 12

COPPER 13

PRE-PAINTED SHEET IRON 14

BIRD WIRE 16

## ACCESSORIES

FIXING COMPONENTS 19

# BIRDS

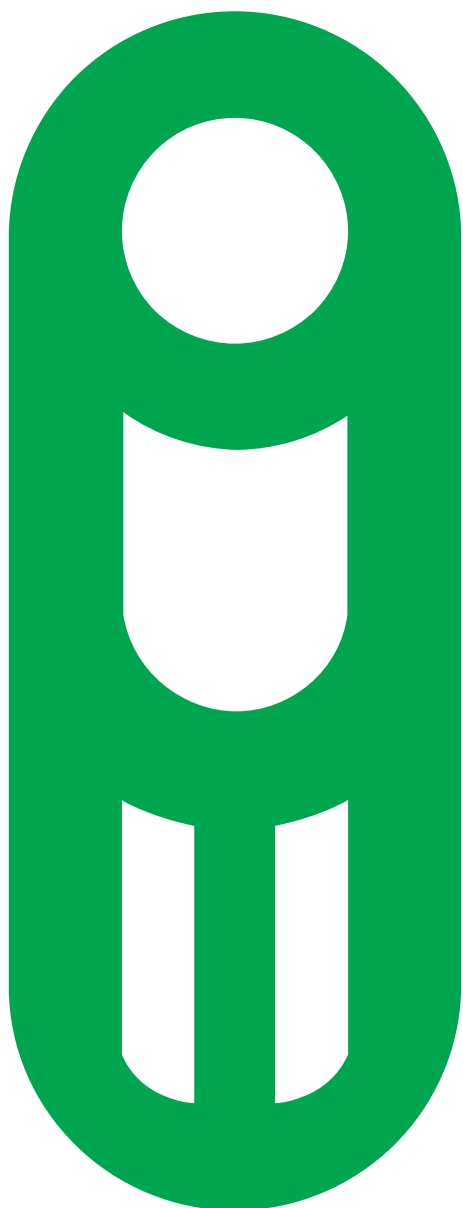



# BIRD CONTROL

## ANTI-PERCHING SYSTEMS

### POLYCARBONATE + STEEL

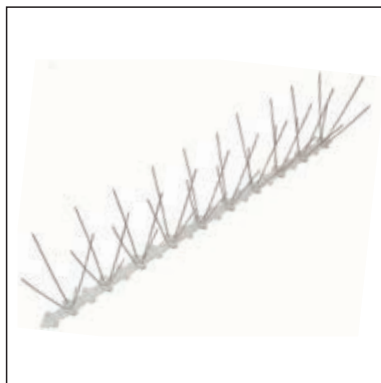

PATENT PENDING  
★TOP PRODUCT



#### A BIRD SPIKE WITH 80 PINS / METRE

Versatile, quick to install bird spike that is certainly one of the most effective deterrent methods on the market.

This practical bird spike is designed to ensure maximum coverage and protection in any situation. For use in the presence of **medium / high bird infestation levels** on all types of surfaces requiring good coverage.

It can be fastened using silicone adhesive, self-tapping screws, rivets, anchor screws, etc.

The bird spike does not deform over time since it has a UV-treated polycarbonate base that is corrosion and weather resistant while the pins are made of high quality stainless steel.

#### TECHNICAL DATA

Length:	500 mm
No. of pins:	40 in 500 mm (80 in a metre)
Coverage:	100 mm
Fixing holes:	Ø 4 mm
<b>BASE</b>	
Material:	UV-treated polycarbonate
<b>PINS</b>	
Material:	Stainless steel
Length:	110 mm
Diameter:	1.3 mm

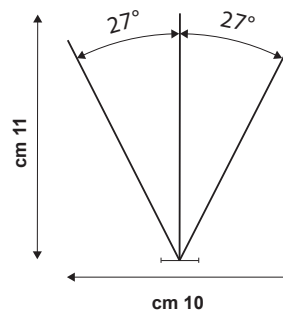

<b>Code:</b>	<b>Pack:</b>	<b>Pallet:</b>
304	50 m / carton	20 cts / pallet

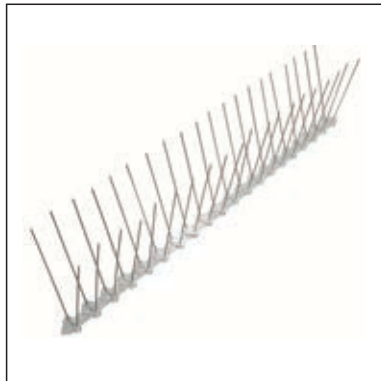

PATENT PENDING



#### B BIRD SPIKE WITH 80 PINS / METRE

Versatile, quick to install bird spike that is certainly one of the most effective deterrent methods on the market.

This practical bird spike is designed to ensure maximum coverage and protection in any situation. For use in the presence of **medium / low bird infestation levels** on all types of surfaces requiring good coverage. It can be fastened using silicone adhesive, self-tapping screws, rivets, anchor screws, etc.

The bird spike does not deform over time since it has a UV-treated polycarbonate base that is corrosion and weather resistant while the pins are made of high quality stainless steel.

#### TECHNICAL DATA

Length:	500 mm
No. of pins:	40 in 500 mm (80 in a metre)
Coverage:	70 mm
Fixing holes:	Ø 4 mm
<b>BASE</b>	
Material:	UV-treated polycarbonate
<b>PINS</b>	
Material:	Stainless steel
Length:	110 mm
Diameter:	1.3 mm

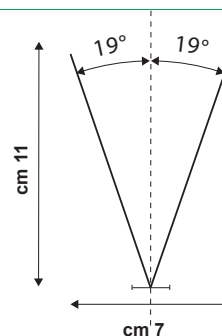

<b>Code:</b>	<b>Pack:</b>	<b>Pallet:</b>
305	50 m / carton	28 cts / pallet



# BIRD CONTROL

## ANTI-PERCHING SYSTEMS

### POLYCARBONATE + STEEL

#### A BIRD SPIKE WITH 120 PINS / METRE

Versatile, quick to install bird spike that is certainly one of the most effective deterrent methods on the market.

This practical bird spike is designed to ensure maximum coverage and protection in any situation. For use in the presence of **extremely high bird infestation levels** on all types of surfaces requiring good coverage. It can be fastened using silicone adhesive, self-tapping screws, rivets, anchor screws, etc.

The bird spike does not deform over time since it has a UV-treated polycarbonate base that is corrosion and weather resistant while the pins are made of high quality stainless steel.

#### TECHNICAL DATA

Length: 500 mm  
No. of pins: 60 in 500 mm (120 in a metre)  
Coverage: 160 mm  
Fixing holes: Ø 4 mm

#### BASE

Material: UV-treated polycarbonate

#### PINS

Material: Stainless steel  
Length: 100 mm  
Diameter: 1.3 mm

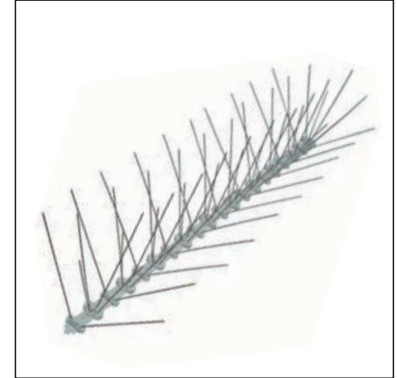
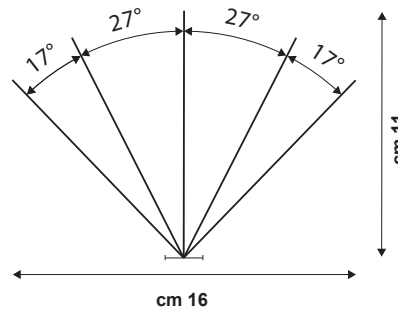

PATENT PENDING  
★TOP PRODUCT

Code:

306

Pack:

50 m / carton

Pallet:

12 cts / pallet

#### B BIRD SPIKE WITH 40 PINS / METRE

Versatile, quick to install bird spike that is certainly one of the most effective deterrent methods on the market.

This practical bird spike is designed to ensure maximum coverage and protection in any situation. For use in the presence of **medium / low bird infestation levels** on all types of surfaces requiring good coverage. It can be fastened using silicone adhesive, self-tapping screws, rivets, anchor screws, etc.

The bird spike does not deform over time since it has a UV-treated polycarbonate base that is corrosion and weather resistant while the pins are made of high quality stainless steel.

#### TECHNICAL DATA

Length: 500 mm  
No. of pins: 20 in 500 mm (40 in a metre)  
Coverage: Longitudinal  
Fixing holes: Ø 4 mm

#### BASE

Material: UV-treated polycarbonate

#### PINS

Material: Stainless steel  
Length: 100 mm  
Diameter: 1.3 mm

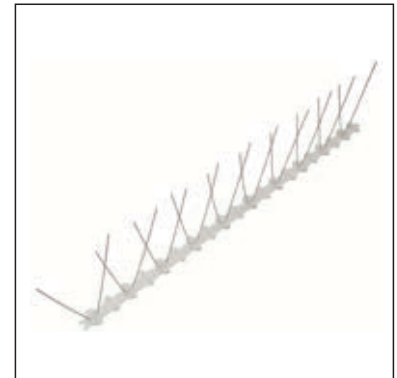

PATENT PENDING

Code:

307

Pack:

100 m / carton

Pallet:

20 cts / pallet

# BIRD CONTROL

## ANTI-PERCHING SYSTEMS

### POLYCARBONATE + STEEL

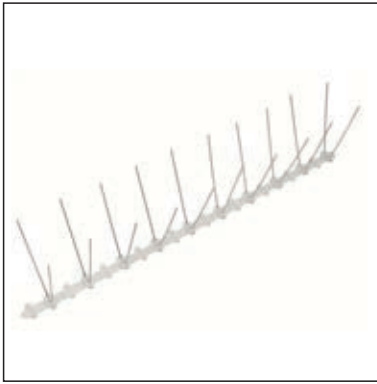

**PATENT PENDING**  
**★TOP PRODUCT**



#### **A** BIRD SPIKE WITH 40 PINS / METRE

Versatile, quick to install bird spike that is certainly one of the most effective deterrent methods on the market.

This practical bird spike is designed to ensure maximum coverage and protection in any situation. For use in the presence of **low bird infestation levels** on all types of surfaces. It can be fastened using silicone adhesive, self-tapping screws, rivets, anchor screws, etc.

The bird spike does not deform over time since it has a UV-treated polycarbonate base that is corrosion and weather resistant while the pins are made of high quality stainless steel.

#### TECHNICAL DATA

Length:	500 mm
No. of pins:	20 in 500 mm (40 in a metre)
Coverage:	70 mm
Fixing holes:	Ø 4 mm
<b>BASE</b>	
Material:	UV-treated polycarbonate
<b>PINS</b>	
Material:	Stainless steel
Length:	110 mm
Diameter:	1.3 mm

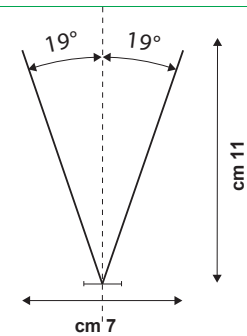

Code:	Pack:	Pallet:
308	100 m / carton	20 cts / pallet

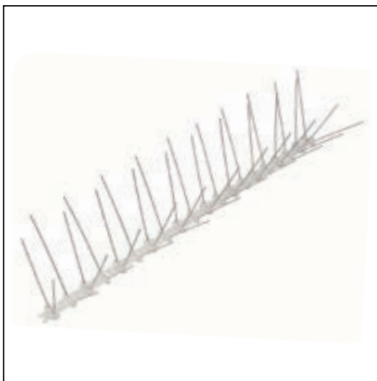

**PATENT PENDING**  
**★TOP PRODUCT**



#### **B** BIRD SPIKE WITH 80 PINS / METRE

Versatile, quick to install bird spike that is certainly one of the most effective deterrent methods on the market.

This practical bird spike is designed to ensure maximum coverage and protection in any situation. For use in the presence of **medium / high bird infestation levels** on all types of surfaces requiring good coverage. It can be fastened using silicone adhesive, self-tapping screws, rivets, anchor screws, etc.

The bird spike does not deform over time since it has a UV-treated polycarbonate base that is corrosion and weather resistant while the pins are made of high quality stainless steel.

#### TECHNICAL DATA

Length:	500 mm
No. of pins:	40 in 500 mm (80 in a metre)
Coverage:	160 mm
Fixing holes:	Ø 4 mm
<b>BASE</b>	
Material:	UV-treated polycarbonate
<b>PINS</b>	
Material:	Stainless steel
Length:	110 mm
Diameter:	1.3 mm

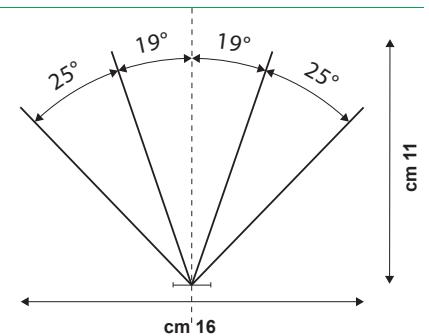

Code:	Pack:	Pallet:
311	50 m / carton	20 cts / pallet

# BIRD CONTROL

## ANTI-PERCHING SYSTEMS

### POLYCARBONATE + STEEL

#### A BIRD SPIKE WITH 80 PINS / METRE

Versatile, quick to install bird spike that is certainly one of the most effective deterrent methods on the market.

This practical bird spike is designed to ensure maximum coverage and protection in any situation. For use in the presence of **medium bird infestation levels** on all types of surfaces requiring good coverage. It can be fastened using silicone adhesive, self-tapping screws, rivets, anchor screws, etc. The bird spike does not deform over time since it has a UV-treated polycarbonate base that is corrosion and weather resistant while the pins are made of high quality stainless steel.

##### TECHNICAL DATA

Length: 500 mm  
No. of pins: 40 in 500 mm (80 in a metre)  
Coverage: 160 mm  
Fixing holes: Ø 4 mm

##### BASE

Material: UV-treated polycarbonate

##### PINS

Material: Stainless steel  
Length: 110 mm  
Diameter: 1.3 mm

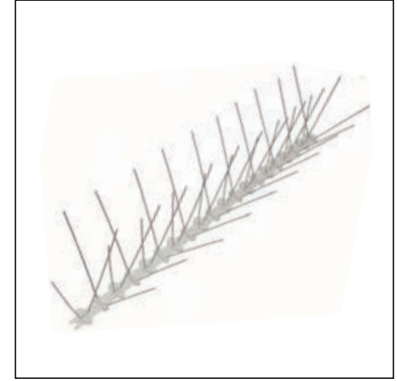
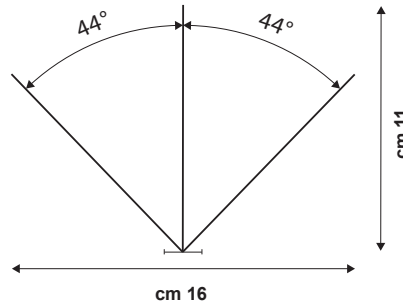

PATENT PENDING

Code:	Pack:	Pallet:
312	50 m / carton	12 cts / pallet

#### B BIRD SPIKE WITH 60 PINS / METRE

Versatile, quick to install bird spike that is certainly one of the most effective deterrent methods on the market.

This practical bird spike is designed to ensure maximum coverage and protection in any situation. For use in the presence of **medium / low bird infestation levels** on all types of surfaces requiring good coverage. It can be fastened using silicone adhesive, self-tapping screws, rivets, anchor screws, etc.

The bird spike does not deform over time since it has a UV-treated polycarbonate base that is corrosion and weather resistant while the pins are made of high quality stainless steel.

##### TECHNICAL DATA

Length: 500 mm  
No. of pins: 30 in 500 mm (60 in a metre)  
Coverage: 70 mm  
Fixing holes: Ø 4 mm

##### BASE

Material: UV-treated polycarbonate

##### PINS

Material: Stainless steel  
Length: 110 mm  
Diameter: 1.3 mm

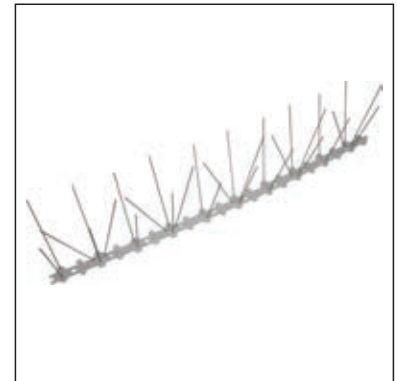
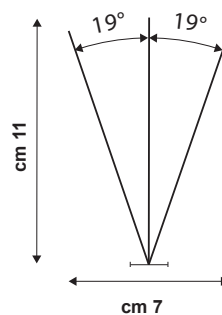

PATENT PENDING

Code:	Pack:	Pallet:
360	50 m / carton	20 cts / pallet

# BIRD CONTROL

## ANTI-PERCHING SYSTEMS

### POLYCARBONATE + STEEL

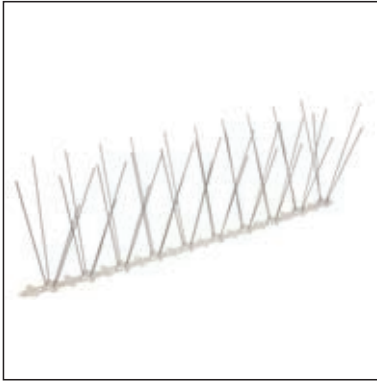

PATENT PENDING



#### **A** BIRD SPIKE FOR SEAGULLS WITH 80 PINS/MT

Special development of the bird spike model 304, this item has been designed to protect surfaces from seagulls' longer legs; pins length has been increased to 160 mm to ensure maximum protection.

Suitable in the presence of **medium / high seagull infestation level** and with a perching surface of 10/15 cm. It can be fastened using silicone, screws, rivets, etc.

Made from stainless steel wires protruding from a UV stabilised polycarbonate base, this product is designed with long service life in mind.

#### TECHNICAL DATA

Length:	500 mm
No. of pins:	40 in 500 mm (80 in 1000 mm)
Coverage:	110 mm
Fixing holes:	Ø 4 mm
<b>BASE</b>	
Material:	UV-treated polycarbonate
<b>PINS</b>	
Material:	Stainless steel
Length:	160 mm
Diameter:	1.3 mm

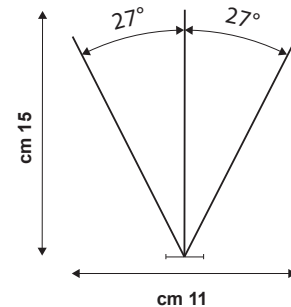

<b>Code:</b>	<b>Pack:</b>	<b>Pallet:</b>
304G	25 m / carton	20 cts / pallet

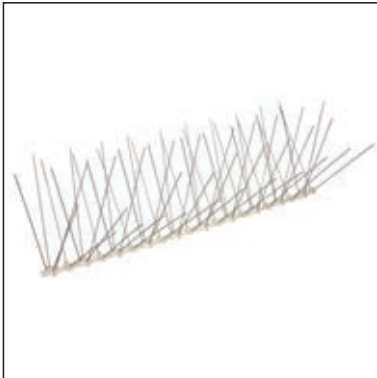

PATENT PENDING



#### **B** BIRD SPIKE FOR SEAGULLS WITH 120 PINS/MT

Special development of the bird spike model 306, this item has been designed to protect surfaces from seagulls' longer legs; pins length has been increased to 160 mm to ensure maximum protection.

Suitable in the presence of **extremely high seagull infestation levels** and with a perching surface of 20/25 cm. It can be fastened using silicone, screws, rivets, etc.

Made from stainless steel wires protruding from a UV stabilised polycarbonate base, this product is designed with long service life in mind.

#### TECHNICAL DATA

Length:	500 mm
No. of pins:	60 in 500 mm (120 in 1000 mm)
Coverage:	250 mm
Fixing holes:	Ø 4 mm
<b>BASE</b>	
Material:	UV-treated polycarbonate
<b>PINS</b>	
Material:	Stainless steel
Length:	160 mm
Diameter:	1.3 mm

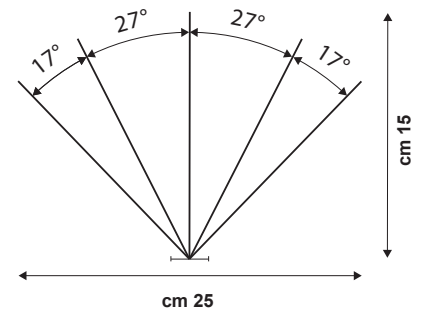

<b>Code:</b>	<b>Pack:</b>	<b>Pallet:</b>
306G	25 m / carton	20 cts / pallet

# BIRD CONTROL

## ANTI-PERCHING SYSTEMS

### POLYCARBONATE + STEEL

#### A BIRD SPIKE FOR SEAGULLS WITH 80 PINS/MT

Special development of the bird spike model 311, this item has been designed to protect surfaces from seagulls' longer legs; pins length has been increased to 160 mm to ensure maximum protection.

Suitable in the presence of **medium / high seagull infestation level** and with a perching surface of 20/25 cm. It can be fastened using silicone, screws, rivets, etc.

Made from stainless steel wires protruding from a UV stabilised polycarbonate base, this product is designed with long service life in mind.

#### TECHNICAL DATA

Length:	500 mm
No. of pins:	40 in 500 mm (80 in 1000 mm)
Coverage:	230 mm
Fixing holes:	Ø 4 mm
<b>BASE</b>	
Material:	UV-treated polycarbonate
<b>PINS</b>	
Material:	Stainless steel
Length:	160 mm
Diameter:	1.3 mm

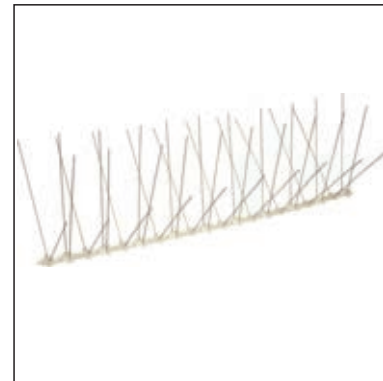
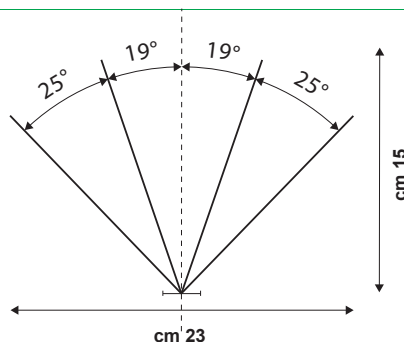

PATENT PENDING

<b>Code:</b>	<b>Pack:</b>	<b>Pallet:</b>
311G	25 m / carton	20 cts / pallet

## STEEL

#### B STAINLESS STEEL SPIRAL FOR GUTTERS PROTECTION

Special spiral in harmonic stainless steel designed to protect gutters from pest birds. The spring has a wide diameter, thus allowing an easy flow of water.

Totally harmless to birds, it guarantees the protection of surfaces with a width of 10/12 cm and a length of 2/3 mt. It comes in kit with 2 fixing curls mod 51.

#### TECHNICAL DATA

Length:	max 4000 mm
Width:	100 mm
Thickness:	1.2 mm
Material:	Stainless steel
Nr of coils:	Approx 70
Coverage:	Ideal 2000/3000 mm

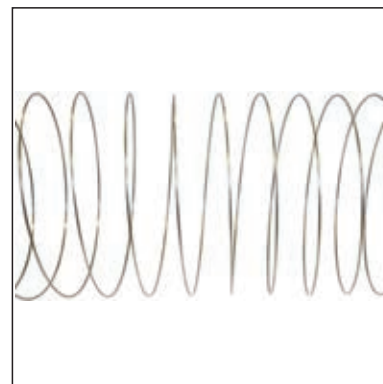

<b>Code:</b>	<b>Pack:</b>	<b>Carton:</b>
825	1 pc / pack	---

# BIRD CONTROL

## ANTI-PERCHING SYSTEMS

### POLYCARBONATE

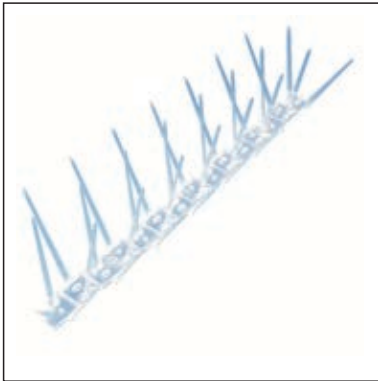

#### **A** POLYCARBONATE BIRD SPIKE WITH 60 PINS / METRE

Versatile bird spike that is quick to install owing to its 500 mm length. It is certainly one of the most effective deterrent methods on the market.

This practical bird spike is designed to ensure maximum coverage and protection in any situation. For use in the presence of **medium bird infestation levels**, it is suitable for all types of surfaces that require wide coverage. It can be fastened using silicone adhesive, self-tapping screws, rivets, anchor screws, etc.

The bird spike does not deform over time since it is entirely made of UV-treated polycarbonate that is corrosion and weather resistant. Harmless to birds.

#### TECHNICAL DATA

Length:	500 mm
No. of pins:	30 in 500 mm (60 in a metre)
Coverage:	130 mm
Fixing holes:	Ø 4 mm
Material:	UV-treated polycarbonate
<b>PINS</b>	
Shape:	Conical
Length:	110 mm
Diameter:	From 5 to 1 mm

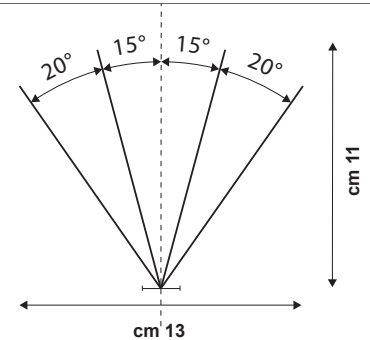

<b>Code:</b>	<b>Pack:</b>	<b>Pallet:</b>
350	50 m / carton	20 cts / pallet

### COPPER

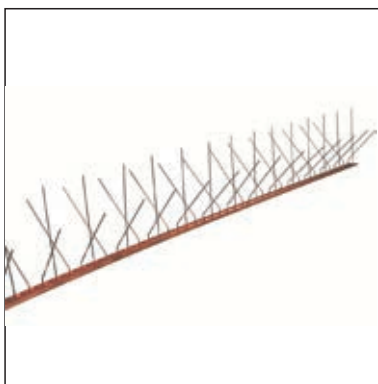

#### **B** COPPER BIRD SPIKE 66 PINS / METRE

Bird spike with copper base. For use in the presence of medium bird infestation levels, this bird spike is suitable for all types of surfaces.

It is especially recommended for use on prestigious buildings that require a nice visual impact. It can be fastened using silicone adhesive, self-tapping screws, rivets, anchor screws, etc.

The copper base and phosphor bronze pins provide aesthetically pleasing results.

#### TECHNICAL DATA

Length:	1000 mm
No. of pins:	66 in a metre
Coverage:	120 mm
Fixing holes:	Ø 4.5 mm
<b>BASE</b>	
Material:	Copper
<b>PINS</b>	
Material:	Phosphor bronze
Length:	100 mm
Diameter:	1.3 mm

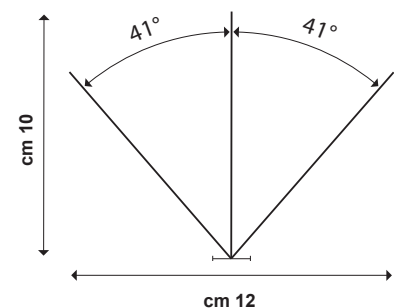

<b>Code:</b>	<b>Pack:</b>	<b>Pallet:</b>
309	50 m / carton	---

# BIRD CONTROL

## ANTI-PERCHING SYSTEMS

### COPPER

#### A ORNAMENTAL SPIKE 6/10 MM THICKNESS

This bird deterrent is suitable for use in the presence of medium bird infestation levels. It is designed to protect the gutters and flashing of roofs. It is especially recommended for use on prestigious buildings that require a nice visual impact. It can be fastened using self-tapping screws, rivets, anchor screws, etc. Fastened in the front.

##### TECHNICAL DATA

Material:	Copper
Length:	1000 mm
Thickness:	0.6 mm
No. of pins:	50 in a metre
Length:	60 mm
Distance between pins:	20 mm
Fixing holes:	Ø 4 mm
Fixing:	Frontal



Code:	Pack:	Pallet:
601	50 m / carton	---

#### B ORNAMENTAL SPIKE 6/10 MM THICKNESS

This bird deterrent is suitable for use in the presence of medium bird infestation levels. It is designed to protect the gutters and flashing of roofs. It is especially recommended for use on prestigious buildings that require a nice visual impact. It can be fastened using self-tapping screws, rivets, anchor screws, etc. Fastened from the top.

##### TECHNICAL DATA

Material:	Copper
Length:	1000 mm
Thickness:	0.6 mm
No. of pins:	50 in a metre
Length:	60 mm
Distance between pins:	20 mm
Fixing holes:	Ø 4 mm
Fixing:	From the top

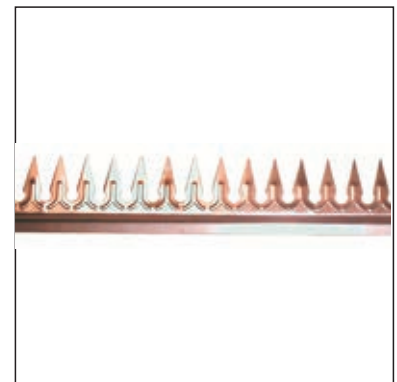

Code:	Pack:	Pallet:
602	50 m / carton	---

#### C ORNAMENTAL SPIKE 6/10 MM THICKNESS

This bird deterrent is suitable for use in the presence of medium bird infestation levels. It is designed to protect the tops of downpipes. It is especially recommended for use on prestigious buildings that require a nice visual impact. It can be fastened using self-tapping screws, rivets, anchor screws, etc. Fastened from the top.

##### TECHNICAL DATA

Material:	Copper
Length:	1000 mm
Thickness:	0.6 mm
No. of pins:	50 + 50 in a metre
Length:	40 mm
Distance between pins:	20 mm
Fixing holes:	Ø 4 mm
Fixing:	From the top

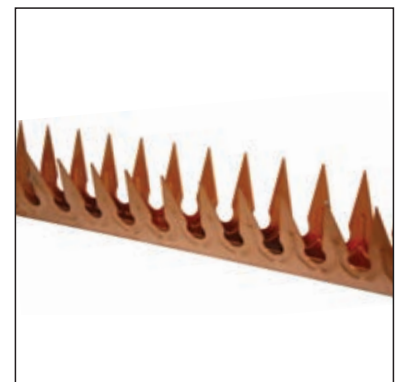

Code:	Pack:	Pallet:
603	20 m / carton	---

# BIRD CONTROL

## ANTI-PERCHING SYSTEMS

### PRE-PAINTED SHEET IRON



#### **A** ORNAMENTAL SPIKE 6/10 MM THICKNESS

This bird deterrent is suitable for use in the presence of medium bird infestation levels. It is designed to protect the gutters and flashing of roofs. It is especially recommended for use on prestigious buildings that require a nice visual impact. It can be fastened using self-tapping screws, rivets, anchor screws, etc. Fastened in the front.

##### TECHNICAL DATA

Material:	Pre-painted sheet iron
Length:	1000 mm
Thickness:	0.6 mm
No. of pins:	50 in a metre
Length:	60 mm
Distance between pins:	20 mm
Fixing holes:	Ø 4 mm
Fixing:	Frontal



Code:	Pack:	Pallet:
611	50 m / carton	---



#### **B** ORNAMENTAL SPIKE 6/10 MM THICKNESS

This bird deterrent is suitable for use in the presence of medium bird infestation levels. It is designed to protect the gutters and flashing of roofs. It is especially recommended for use on prestigious buildings that require a nice visual impact. It can be fastened using self-tapping screws, rivets, anchor screws, etc. Fastened from the top.

##### TECHNICAL DATA

Material:	Pre-painted sheet iron
Length:	1000 mm
Thickness:	0.6 mm
No. of pins:	50 in a metre
Length:	60 mm
Distance between pins:	20 mm
Fixing holes:	Ø 4 mm
Fixing:	From the top



Code:	Pack:	Pallet:
612	50 m / carton	---



#### **C** ORNAMENTAL SPIKE 6/10 MM THICKNESS

This bird deterrent is suitable for use in the presence of medium bird infestation levels. It is designed to protect the tops of downpipes. It is especially recommended for use on prestigious buildings that require a nice visual impact. It can be fastened using self-tapping screws, rivets, anchor screws, etc. Fastened from the top.

##### TECHNICAL DATA

Material:	Pre-painted sheet iron
Length:	1000 mm
Thickness:	0.6 mm
No. of pins:	50 + 50 in a metre
Length:	40 mm
Distance between pins:	20 mm
Fixing holes:	Ø 4 mm
Fixing:	From the top



Code:	Pack:	Pallet:
613	20 m / carton	---





**BIRDS<sup>®</sup>**

**LEADING BRAND IN BIRD CONTROL**



# BIRD CONTROL

## ANTI-PERCHING SYSTEMS

### BIRD WIRE

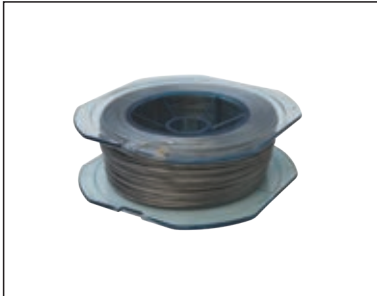

#### **A** STAINLESS STEEL WIRE 0.7 MM

Special stainless steel wire coated with UV-treated nylon. Available in practical plastic spools with 100 metres of wire.

##### TECHNICAL DATA

Material: Stainless steel + UV-treated sheath  
Diameter: 0.7 mm  
Load resistance: 22 kg

Code:	Pack:	Carton:
121	100 m / pack	---



#### **B** TIN-PLATED BRASS CRIMPS FOR 0.7 MM WIRE

Special crimps made of tin-plated brass, used to secure the stainless steel wire to the split pins or posts.

##### TECHNICAL DATA

Material: Tin-plated brass  
Diameter: 2 mm  
Length: 8 mm

Code:	Pack:	Carton:
131	100 pcs / pack	---



#### **C** NYLON ANCHOR RIVETS

Special hammer in anchor rivets with dome-shaped cap to prevent rainwater infiltration. The anchor rivets provide secure connection to the split pins and posts.

##### TECHNICAL DATA

Material: Nylon  
Diameter: 6.5 mm

Code:	Length:	Pack:	Carton:
141	25 mm	100 pcs / pack	---
142	38 mm	100 pcs / pack	---



#### **D** STAINLESS STEEL SPLIT PINS

Standard stainless steel split pins for use as a wall anchorage point for the stainless steel wire. Perfect for mod. 141 and 142 anchor rivets.

##### TECHNICAL DATA

Material: Stainless steel  
Diameter: 4 mm

Code:	Length:	Pack:	Carton:
151	25 mm	100 pcs / pack	---
152	38 mm	100 pcs / pack	---

# BIRD CONTROL

## ANTI-PERCHING SYSTEMS

### BIRD WIRE

#### A STAINLESS STEEL SPRINGS

Stainless steel extension springs specially designed with slightly open eyelet to allow quick connection to the split pin or post.

##### TECHNICAL DATA

Material: Stainless steel  
Diameter: 8 mm

Code:	Length:	Pack:	Carton:
161	37 mm	100 pcs / pack	---
162	20 mm	100 pcs / pack	---



#### B STAINLESS STEEL POSTS

Stainless steel posts with 4 mm diameter hole/s, used to anchor mod. 121 wire. They can either be fitted into the special nylon base (mod. 185) or inserted directly into nylon anchor rivets. Available with 1, 2 or 3 holes and different length.

##### TECHNICAL DATA

Material: Stainless steel  
Diameter: 4 mm

Code:	Length:	No. of holes:	Pack:	Carton:
169	95 mm	1	100 pcs / pack	---
170	125 mm	1	100 pcs / pack	---
171	115 mm	1	100 pcs / pack	---
172	150 mm	1	100 pcs / pack	---
173	180 mm	1	100 pcs / pack	---
174	130 mm	2	100 pcs / pack	---
175	150 mm	2	100 pcs / pack	---
176	180 mm	3	100 pcs / pack	---



#### C Y-SHAPED 125 MM STAINLESS STEEL POST

Special stainless steel Y-shaped bird wire post, ideal for use in situations when the number of mod. 185 bases must be optimised. With a thread on the end, it can also be screwed to a base plate.

##### TECHNICAL DATA

Material: Stainless steel  
Diameter: 3.5 mm  
Height: 125 mm  
Distance between tips: 70 mm

Code:	Pack:	Carton:
177	10 pcs / pack	---



# BIRD CONTROL

## ANTI-PERCHING SYSTEMS

### BIRD WIRE



#### **A** BIRD WIRE POSTS COMPLETE WITH BASE

Stainless steel bird wire posts with special nylon base, for quick fastening using silicone or screws on any surface.

##### TECHNICAL DATA

Material: Stainless steel + nylon base  
Post diameter: 4 mm  
Base dimensions: 40 x 40 mm

Code:	Post length:	Pack:	Carton:
181	95 mm	10 pcs / pack	---
182	125 mm	10 pcs / pack	---



#### **B** NYLON BASE FOR BIRD WIRE POSTS

Special nylon bases used to anchor bird wire posts on any surface. Specially designed to provide secure fixing using silicone or screws.

##### TECHNICAL DATA

Material: Nylon  
Base dimensions: 40 x 40 mm

Code:	Pack:	Carton:
185	10 pcs / pack	---



#### **C** STAINLESS STEEL POSTS WITH CLAMP AND HORIZONTAL SCREW

Posts with clamp and screw, used to secure bird wire on the edges of gutters, etc. They have plastic pads to avoid ruining the surfaces on which they are fixed. Maximum width 20 mm.

##### TECHNICAL DATA

Material: Stainless steel  
Diameter: 4 mm  
No. of holes: 1  
Length: 95 mm  
Clamp: Suitable for widths from 1 to 20 mm

Code:	Pack:	Carton:
186	10 pcs / pack	---



#### **D** STAINLESS STEEL POSTS WITH CLAMP AND VERTICAL SCREW

Posts with clamp and vertical screw, used to secure bird wire to handrails, parapets or other edges with a maximum width of 20 mm. They have plastic pads to avoid ruining the surfaces on which they are fixed.

##### TECHNICAL DATA

Material: Stainless steel  
Diameter: 4 mm  
No. of holes: 1  
Length: 95 mm  
Clamp: Suitable for widths from 1 to 20 mm

Code:	Pack:	Carton:
187	10 pcs / pack	---

# BIRD CONTROL

## ACCESSORIES

### FIXING COMPONENTS

#### **A** GALVANISED CLAMP-ON CLIPS

Specifically designed to anchor the steel wire to metal bases. These very sturdy clips are simply clamped on with the help of a hammer. Special inner wings provide the clips with excellent grip, ensuring secure anchorage and high resistance also to tensile stress. Available in 4 sizes.

##### TECHNICAL DATA

Material: Galvanised steel

Code:	Thickness:	Pack:	Carton:
555	From 1,5 to 3 mm	100 pcs / pack	---
556	From 3 to 8 mm	100 pcs / pack	---
557	From 8 to 14 mm	100 pcs / pack	---
558	From 14 to 20 mm	100 pcs / pack	---

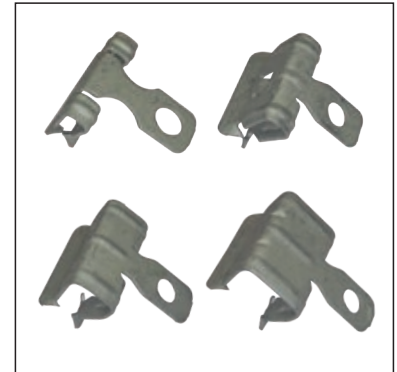

**Mod. 555**



**Mod. 556**



**Mod. 557**



**Mod. 558**

#### **B** HIGH PERFORMANCE SPECIFIC ADHESIVE

Mod 464 is a one part, moisture curing sealant, crystal clear even in thickness. It provides high elasticity and cohesion and good adhesion to a wide range of substrates. It produces high resistance elastic sealings. It can be used as adhesive in bonding requiring transparency and high filling capacity.

##### TECHNICAL DATA

Material: High quality neutral reticulation single-compound

Colour: Transparent

Cartridge content: 290 ml

Code:	Pack:	Carton:
464	1 pc / pack	24 pcs / carton



★ TOP PRODUCT

# BIRD CONTROL

## ACCESSORIES

### FIXING COMPONENTS



#### **A** STAINLESS STEEL BOLT FOR CLAMP-ON CLIPS

Stainless steel bolt used for fixing the polycarbonate spike base to the clamp-on clips. This anchorage makes it possible to install bird spikes even in case of particularly thin profiles.

##### TECHNICAL DATA

Material: Stainless steel

Code:	Pack:	Carton
391	100 pcs / pack	---



#### **B** STAINLESS STEEL NUT FOR CLAMP-ON CLIPS

Stainless steel nut used for assembling the bird spike base with the percussion clip. This anchorage allows the installation of bird spikes even in the presence of particularly thin profiles.

##### TECHNICAL DATA

Material: Stainless steel

Code:	Pack:	Carton
392	100 pcs / pack	---



#### **C** STAINLESS STEEL WASHER FOR CLAMP-ON CLIPS

Stainless steel washer used for assembling the bird spike base with the clamp-on clip. This anchorage allows the installation of bird spikes even in the presence of particularly thin profiles.

##### TECHNICAL DATA

Material: Stainless steel

Code:	Pack:	Carton
393	100 pcs / pack	---

# BIRD CONTROL

## ACCESSORIES

### FIXING COMPONENTS

#### A NYLON WALL PLUGS

Used to perfectly anchor screws to masonry walls.

##### TECHNICAL DATA

Material: Nylon

Code:	Dimensions:	Combine with:	Pack:	Carton
402	20 x ø 4 mm	403	100 pcs / pack	---
406	25 x ø 5 mm	407	100 pcs / pack	---



#### B STAINLESS STEEL SELF-TAPPING SCREWS

Stainless steel self-tapping screws with cylinder Phillips head.

##### TECHNICAL DATA

Material: Stainless steel

Code:	Dimensions:	Combine with:	Pack:	Carton:
403	3.0 x 20 mm	402	100 pcs / pack	---
407	3.5 x 25 mm	406	100 pcs / pack	---



#### C NYLON UV-TREATED CABLE TIES

Special nylon cable ties in black colour, with a highly effective fastening system and resistant to UV rays, oils, fats and solvents in general.

##### TECHNICAL DATA

Material: Self-extinguishing nylon

Colore: Black

Code:	Dimensions:	Pack:	Carton:
545	200 x 4.5 mm	100 pcs / pack	---
546	280 x 7.5 mm	100 pcs / pack	---
547	360 x 7.5 mm	100 pcs / pack	---



# BIRD CONTROL

## ELECTRIC LINE

ENERGISERS	24
LINE COMPONENTS	26
FIXING COMPONENTS	31
INSTALLATION TIPS	34

# BIRDS

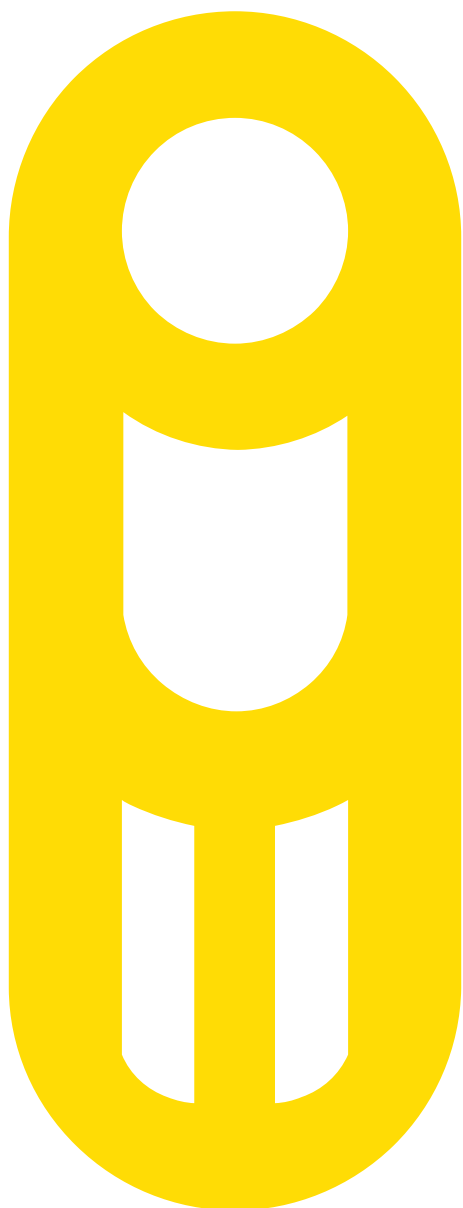





# BIRD CONTROL

## ELECTRIC LINE

### ENERGISERS



#### **A** DIGITAL CONTROL BOX

**The only control box on the market with two separate channels.**

The 4th generation ECOBIRDS electronic bird control system features a digital control box with a "user-friendly" interface to set all the function parameters and to monitor the correct functioning of the electric lines.

The total impulse energy can be digitally adjusted from a minimum of 1 J to maximum 5 J.

The time interval between the impulses can also be adjusted so that each system is tailored to real needs.

In the event of a short circuit, the control box signals the problem through a LED positioned on the lid and/or by sending an SMS to the mobile phone of the operator responsible for the system's maintenance (for the optional mod. GSM).

Power supply: 110V or 220V AC 50 Hz

Impulse: two separate channels with independent programming

Software-controlled power

Automatic counting of the distance of short circuit from the control box: after setting simple parameters, this function allows you to identify the exact position of the short circuit expressed in metres from the beginning of the line.

Default settings that can be modified to suit personal preferences after entering password

3-digit interface display with 3 buttons

Possibility of customising cover

EC Certificate of Conformity and electromagnetic compatibility provided upon request

DIGITAL PROGRAMMING WITH 3-DIGIT DISPLAY

PASSWORD FOR MODIFICATION OF DEFAULT PARAMETERS

#### TECHNICAL DATA (EC standards)

Power supply: 110V/220V

Mains frequency: 50 Hz

Absorption: 25-45 mA

Power consumption: 11 VA peak; average 1.5W/h with AC power

Operating voltage: 12 V

Operating output voltage: 4.0 KV – 12 KV

Output energy: 1-5 J

Interval between impulses: 0.8 - 100 seconds

Operating temperature: Min. -20°C max +85°C

#### STRUCTURAL FEATURES

Insulation class: IP55

Fire resistance: Self-extinguishing

Water absorption resistance: 45 mg

Flow passage resistance: 180 KV/cm<sup>2</sup>

Shock resistance: 50 kg/cm<sup>2</sup>

Temperature resistance: Min. -25°C max +120°C

Dimensions: 170 x 140 x 80 mm

Code:	Electric line:	Pack:	Carton:
205	up to 200 m	1 pc / pack	---
505	up to 500 m	1 pc / pack	---
905	up to 1000 m	1 pc / pack	---
205GSM	up to 200 m	1 pc / pack	---
505GSM	up to 500 m	1 pc / pack	---
905GSM	up to 1000 m	1 pc / pack	---

# BIRD CONTROL

## ELECTRIC LINE

### LINE COMPONENTS

#### A COMPLETE ELECTRIC LINE KIT

This kit is specifically designed for 75 metres of electric line and is composed by stainless steel rods, polycarbonate support clamps and stainless steel threaded bushes.

##### TECHNICAL DATA

One kit includes: 100 pcs of threaded bushes made of stainless steel (mod. 411)  
225 pcs of polycarbonate support bases (mod. 420)  
150 linear mt of rods made of annealed stainless steel (mod. 430)

Code:	Pack:	Carton:
497	75 m / pack	---

**AISI 316**

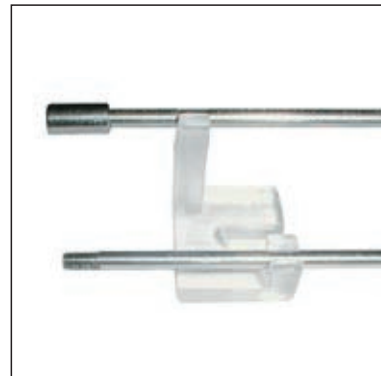

★ NEW PACKAGING  
★ TOP PRODUCT

#### B STAINLESS STEEL THREADED BUSHES FOR 3 MM RODS

For the quick connection of the rods making up the electric line. This through hole threaded bush is a safe and fast way to connect without danger of current leakage. Specially designed to facilitate installation, the bush is countersunk on one side, which helps insert the rod even in difficult situations.

##### TECHNICAL DATA

Material: Stainless steel  
Diameter: 5 mm  
Length: 10 mm  
Thread pitch: M3

Code:	Pack:	Carton:
411	100 pcs / pack	---

**AISI 316**



★ TOP PRODUCT

#### C SUPPORT CLAMPS FOR 3 MM RODS

Supports used to anchor the rods making up the electric line. Suitable for all surfaces, these clamps are to be used for 3 mm diameter rods and can be fastened with rivets, screws and silicone. They feature two posts at different heights, so that the rods can be quickly installed using simple finger pressure. Use one every 30-35 cm.

##### TECHNICAL DATA

Material: High quality UV-protected polycarbonate  
Height of posts: 25 mm / 10 mm  
Base dimensions: 25 x 20 mm  
Slot: 11 x 4 mm

Code:	Pack:	Carton:
420	225 pcs / pack	---



★ TOP PRODUCT

# BIRD CONTROL

## ELECTRIC LINE

### LINE COMPONENTS



#### A READY-TO-USE BARS WITH POLYCARBONATE SUPPORTS

These special long-lasting aluminium bars are already prepared with one riveted polycarbonate base mod 420 every 30 cm. Available in practical 6 mt rolls, mod 498 is a very useful solution for areas where frequent drilling is not allowed nor possible, such as: roof with tiles and pantiles, narrow roof ridges, eaves and ledges made of porous or pierced materials, etc.

##### TECHNICAL DATA

Material: Aluminium  
Bar dimensions: 6000 x 25 x 2 mm  
Number of bases: 20

Code:	Pack:	Carton:
498	6 m / pack	---



★ NEW PACKAGING  
**AISI 316**

#### B THREADED RODS FOR ELECTRIC LINE

##### Annealed stainless steel - Threaded on the ends

Rod for electric line, threaded on the ends so that each can be connected to another with the threaded bushes. Together with the special support clamps, this system reduces installation time by approx. 30-40% compared with other methods available on the market. The rod is made of annealed stainless steel so that it is easier to make curves.

##### TECHNICAL DATA

Length: 1500 mm  
Diameter: 3 mm  
Thread pitch: M3  
Thread length: 5 mm

Code:	Material:	Pack:	Tube:
431	Annealed stainless steel	150 m / pack	100 pcs



#### C THREADED RODS FOR BRANCHES

Special rods threaded on the ends, used for branches, connections, etc.

On one end of the rod, the thread is 5 mm long just like the 150 cm rods of the electric line, while the thread on the other end is 10 mm long for multiple connections requiring more than one cable terminal.

##### TECHNICAL DATA

Material: Annealed stainless steel  
Length: 200 mm  
Diameter: 3 mm  
Thread pitch: M3  
Thread length: 5 mm - 10 mm



Code:	Pack:	Carton:
440	10 pcs / pack	---

# BIRD CONTROL

## ELECTRIC LINE

### LINE COMPONENTS

#### A STAINLESS STEEL SPRINGS

Stainless steel springs for the connection of the electric line 3 mm rods.

##### TECHNICAL DATA

Material: Stainless steel  
Length: 35 mm  
Wire diameter: 0.8 mm  
Spring outer diameter: 4.5 mm  
Spring inner diameter: 2.9 mm  
Number of coils: 28

Code:	Pack:	Carton:
412	100 pcs / pack	---



#### B STAINLESS STEEL 3 MM BRANCH RINGS

Used to create branches of the electric line during installation.  
Branch rings allow installers to create numerous branches, even in narrow places.

##### TECHNICAL DATA

Material: Stainless steel  
Inner diameter: 6 mm  
Length: 9 mm  
Fastening: 1 stainless steel M4 Allen screw



Code:	Pack:	Carton:
413	50 pcs / pack	---



#### C CABLE EYE TERMINALS

Used to connect the high voltage cable to the rod.

##### TECHNICAL DATA

Material: Tin-plated copper  
Length: 9 mm  
Eyelet diameter: 3.2 mm

Code:	Pack:	Carton:
414	100 pcs / pack	---



# BIRD CONTROL

## ELECTRIC LINE

### LINE COMPONENTS



#### A HEAT-SHRINK SHEATH

Used to protect mod. 414 cable eye terminals against weather conditions and UV rays.

##### TECHNICAL DATA

Length: 1220 mm

Code:	Diameter:	Pack	Carton
415	6 mm	6 pcs / pack	---
415B	9 mm	6 pcs / pack	---



#### B STAINLESS STEEL THREADED NUTS

Used to connect the cable terminals mod 414 to the rods.

##### TECHNICAL DATA

Material: Stainless steel  
Thread pitch: M3

Code:	Pack:	Carton:
416	100 pcs / pack	---



#### C HIGH VOLTAGE CABLE

Dual polarised high voltage cable, light grey in colour, with the positive wire striped dark grey.

##### TECHNICAL DATA

Material: Twisted and insulated pure copper conductor.  
Polythene insulation 7/0.3 mm (0.5 mm ).  
Colour: Light grey  
Operating temp.: Max 70° C  
Operating voltage: Max 25 KV



Code:	Pack:	Carton:
480	50 m / pack	---

# BIRD CONTROL

## ELECTRIC LINE

### LINE COMPONENTS

#### A CABLE FASTENERS

Specially designed to anchor mod. 480 high voltage cable.

##### TECHNICAL DATA

Material: UV-protected polycarbonate  
Hole size: 4 mm  
Length: 24 mm  
Width: 10 mm



Code:	Pack:	Carton:
481	100 pcs / pack	---



#### B MAMMOTH CLAMPS FOR 3 MM RODS

Mammoth clamp for the connection of non-threaded rods of the electric line.

##### TECHNICAL DATA

Material: Tin-plated brass  
Dimensions: 14 x 5 mm  
Inner diameter: 3.2 mm  
Fastening: 2 stainless steel M3 Allen screws



Code:	Pack:	Carton:
490	100 pcs / pack	---







#### C DANGER SIGNS

Used to indicate the presence of a high voltage electric line.

##### TECHNICAL DATA

Material: PVC  
Dimensions: 80 x 55 mm

Code:	Language:	Pack:	Carton:
425	Italian 	20 pcs / pack	---
426	English 	20 pcs / pack	---
427	French 	20 pcs / pack	---
428	Spanish 	20 pcs / pack	---



# BIRD CONTROL

## ELECTRIC LINE

### MINI LINE COMPONENTS

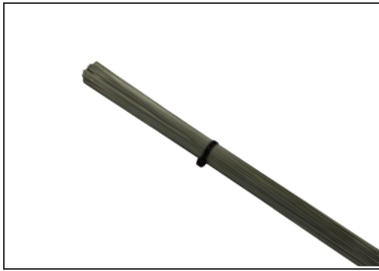

#### A STAINLESS STEEL WIRE IN 1.3 MM RODS

Stainless steel wire with 1.3 mm diameter, suitable for the protection of statues, column capitals, ornaments, etc.. Available in practical 1.5 metre rods.

##### TECHNICAL DATA

Material: Stainless steel  
Length: 1500 mm  
Diameter: 1.3 mm

Code:	Pack:	Tube:
451	300 m / pack	200 pcs



#### B MICRO MAMMOTH CLAMPS FOR 1.3 MM WIRE

Micro-sized mammoth clamp for the proper connection of the steel wire rods. Also used to create branches in mini electric line.

##### TECHNICAL DATA

Material: Nickel-plated brass  
Dimensions: 10 x 4.5 mm  
Inner diameter: 3.0 mm  
Fastening: 2 stainless steel M3 Allen screws

Code:	Pack:	Carton:
452	100 pcs / pack	---



#### C PIN TERMINALS FOR MINI LINE

Pre-insulated push-rod terminal for the connection of the high voltage cable to the wire of the electric line MINI. To use with mod. 452 mammoth clamp.

##### TECHNICAL DATA

Material: Tin-plated copper  
Length: 10 mm  
Pin diameter: 1.8 mm

Code:	Pack:	Carton:
454	100 pcs / pack	---



#### D SUPPORT CLAMPS FOR 1.3 MM WIRE

Support clamp for electric line. It is designed to be fixed to any surface with anchor screws, silicone, rivets, etc. Can be used only with 1.3 mm diameter wire (mod 451).

##### TECHNICAL DATA

Material: High quality UV-protected polycarbonate  
Height of posts: 15.8 mm  
Base dimensions: 20 x 23 mm  
Slot: 11 x 3 mm

Code:	Pack:	Carton:
456	225 pcs / pack	---



# BIRD CONTROL

## ELECTRIC LINE

### FIXING COMPONENTS

#### A GALVANISED CLAMP-ON CLIPS

Specifically designed to anchor the steel wire to metal bases. These very sturdy clips are simply clamped on with the help of a hammer. Special inner wings provide the clips with excellent grip, ensuring secure anchorage and high resistance also to tensile stress. Available in 4 sizes.

##### TECHNICAL DATA

Material: Galvanised steel

Code:	Thickness:	Pack:	Carton:
555	From 1,5 to 3 mm	100 pcs / pack	---
556	From 3 to 8 mm	100 pcs / pack	---
557	From 8 to 14 mm	100 pcs / pack	---
558	From 14 to 20 mm	100 pcs / pack	---

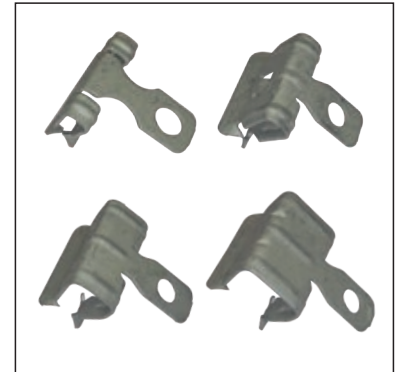

Mod. 555



Mod. 556



Mod. 557



Mod. 558

#### B HIGH PERFORMANCE SPECIFIC ADHESIVE

Mod 464 is a one part, moisture curing sealant, crystal clear even in thickness. It provides high elasticity and cohesion and good adhesion to a wide range of substrates. It produces high resistance elastic sealings. It can be used as adhesive in bonding requiring transparency and high filling capacity.

##### TECHNICAL DATA

Material: High quality neutral reticulation single-compound  
Colour: Transparent  
Cartridge content: 290 ml

Code:	Pack:	Carton:
464	1 pc / pack	24 pcs / carton



★ TOP PRODUCT

# BIRD CONTROL

## ELECTRIC LINE

### FIXING COMPONENTS



#### **A** STAINLESS STEEL BOLT FOR CLAMP-ON CLIPS

Stainless steel bolt used for fixing the polycarbonate spike base to the clamp-on clips. This anchorage makes it possible to install bird spikes even in case of particularly thin profiles.

##### TECHNICAL DATA

Material: Stainless steel

Code:	Pack:	Carton
391	100 pcs / pack	---



#### **B** STAINLESS STEEL NUT FOR CLAMP-ON CLIPS

Stainless steel nut used for assembling the bird spike base with the percussion clip. This anchorage allows the installation of bird spikes even in the presence of particularly thin profiles.

##### TECHNICAL DATA

Material: Stainless steel

Code:	Pack:	Carton
392	100 pcs / pack	---



#### **C** STAINLESS STEEL WASHER FOR CLAMP-ON CLIPS

Stainless steel washer used for assembling the bird spike base with the clamp-on clip. This anchorage allows the installation of bird spikes even in the presence of particularly thin profiles.

##### TECHNICAL DATA

Material: Stainless steel

Code:	Pack:	Carton
393	100 pcs / pack	---

# BIRD CONTROL

## ELECTRIC LINE

### FIXING COMPONENTS

#### A NYLON WALL PLUGS

Used to perfectly anchor screws to masonry walls.

##### TECHNICAL DATA

Material: Nylon

Code:	Dimensions:	Combine with:	Pack:	Carton
402	20 x ø 4 mm	403	100 pcs / pack	---
406	25 x ø 5 mm	407	100 pcs / pack	---



#### B STAINLESS STEEL SELF-TAPPING SCREWS

Stainless steel self-tapping screws with cylinder Phillips head.

##### TECHNICAL DATA

Material: Stainless steel

Code:	Dimensions:	Combine with:	Pack:	Carton:
403	3.0 x 20 mm	402	100 pcs / pack	---
407	3.5 x 25 mm	406	100 pcs / pack	---



#### C NYLON UV-TREATED CABLE TIES

Special nylon cable ties in black colour, with a highly effective fastening system and resistant to UV rays, oils, fats and solvents in general.

##### TECHNICAL DATA

Material: Self-extinguishing nylon

Colore: Black

Code:	Dimensions:	Pack:	Carton:
545	200 x 4.5 mm	100 pcs / pack	---
546	280 x 7.5 mm	100 pcs / pack	---
547	360 x 7.5 mm	100 pcs / pack	---



# BIRD CONTROL

## ELECTRIC LINE INSTALLATION TIPS

### THE POWER BOX



The very first step is to find out the best place where to install the power box. Its IP protection degree is 55; so it can be located also outdoor. However, we suggest, where possible, to install the power box in a sheltered and easy to reach spot, possibly close to the beginning of the electric line. The most common spot is right under the roof, close to the TV aerials, so it is possible to use the same electricity plug; as an alternative, the power box is frequently positioned close to instrument panels such as phone, electricity, etc. Try to keep them away from kids and sensitive areas. The final test and checking of all the power box parameters will be done once the whole line will be installed. The power boxes need a password to have access to the programme area. Give it only to qualified personnel; do not write it on the instruction manual you leave to your customer; remember that any modification of the parameters made by non professional personnel could damage the power box and cause malfunctioning of the line.

### THE CABLE

Once the power box is positioned, connect the high tension cable Mod. 480 following the instructions that are attached to any power box. Unroll the cable from the power box up to the beginning of the line; we recommend to fix the cable by means of the polycarbonate supports Mod. 481.



### CONNECTION CABLE/RODS

Peel the cable by means of the cable stripper Mod. 482; crimp one cable terminal Mod 414 to each pole, then cover it with the UV-treated heat shrinking sheathings Mod. 415-415B. Connect the positive pole to the rod inserted in the upper part of the polycarbonate support Mod.420 by means of two stainless steel nuts Mod. 416, following the sequence rod, nut, cable terminal, nut.



### POLYCARBONATE SUPPORT BASES



Position one base Mod. 420 every 33 cm in case of pigeons and one every 25 cm in presence of seagulls. Remember to install the lower part of the base outwards, facing the direction where birds come from.

# BIRD CONTROL

## ELECTRIC LINE INSTALLATION TIPS

### STAINLESS STEEL RODS

Once the bases have been fixed to the surface, then simply press with fingers the rods into the posts, starting from those connected to the high tension cable.

**WARNING: the positive pole will ALWAYS be positioned in the upper part and the negative one in the lower part. It is recommended to avoid the contact between the negative rod and the surface of the building; however, even in case of accidental contact, the line will not be damaged.**

The rods will be connected to each other by means of the stainless steel threaded bushes Mod.411.

This special device has been specifically designed to make the connection easier and faster; on one side, the hole is cone shaped in order to help the insertion of the next rod. It is recommended to insert all the bushes on the rods when they are still inside the packaging tube, leaving the cone-shaped side outwards. This will help you to save time. In some circumstances, it could be necessary to connect two rods without thread. In these cases, use the special mammoths Mod.490.

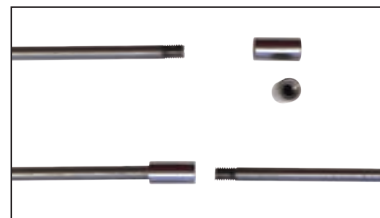

### LINE DERIVATIONS

In some situations, such as lines on different levels, it could be necessary to make derivations to the main line. The ring shunts Mod. 413 are specifically meant for this purpose and, thanks to their stainless steel grain, guarantees a sure fastening and contact between the rods. Bend the new rods at 90° degrees and connect them to the main line with Mod. 413.

The derivation line can run parallel to the main one in case of wide surfaces or point up to a second level, both directly or by means of a High Tension cable connected to the rods as previously described.

In case of multiple cable derivations, it is recommended to use the special rods mod 440, with longer threads.

**WARNING: make sure that, when the rods cross each other at derivations, the distance between them is sufficient to avoid an accidental short circuit.**



### DANGER SIGNS



It is recommended to put some danger signs along the line for signalling its presence. They are available in Italian, English, French and Spanish. They are not required by law in Italy, yet they represent a useful device to avoid accidental contact with the electric line.

**IMPORTANT: the tension on the line has high voltage but VERY LOW AMPERAGE; so it is not dangerous for human beings, animals, etc. However, in case of accidental contact, the person maintaining roof, gutters, etc. could get scared and fall from the stairs.**

### THE FINAL CHECK

The final test should be made by a qualified technician.

All the passages and single components of the line must be checked. The power box must be positioned in a proper place (see previous paragraph) and must produce current continuously, with no interruptions; no short circuit signal must be on. In case the default parameters of the power box have been changed, then a check must be done on its programming. Check that the whole line is properly and safely fixed to the area to be protected by means of weather resistant accessories. Check all the connections and derivations, so that no tension dispersion can occur on the line. Verify that there is a minimum acceptable distance between the positive pole and the protected building. Check all the High Voltage cable connections and the cable/rods connections; they must be done according to the instructions in the previous paragraph. Check the tension on the line; it should approximately correspond to what programmed on the power box. Do not forget that tension dispersion can occur and vary according to the length of the line, the weather conditions (humidity, etc) and the number of connections and derivations. Once you checked all the above-mentioned parameters, then you can declare that the system is conform. The guarantee will start from the date of this official final check.

# BIRD CONTROL

## ANTI-INTRUSION SYSTEMS

POLYETHYLENE NETS	38
NYLON NETS	40
METAL NETS	41
BUDDYSUN	44
BARRIERS	46

## ACCESSORIES

TECHNICAL COMPONENTS	48
FIXING COMPONENTS	51

# BIRDS

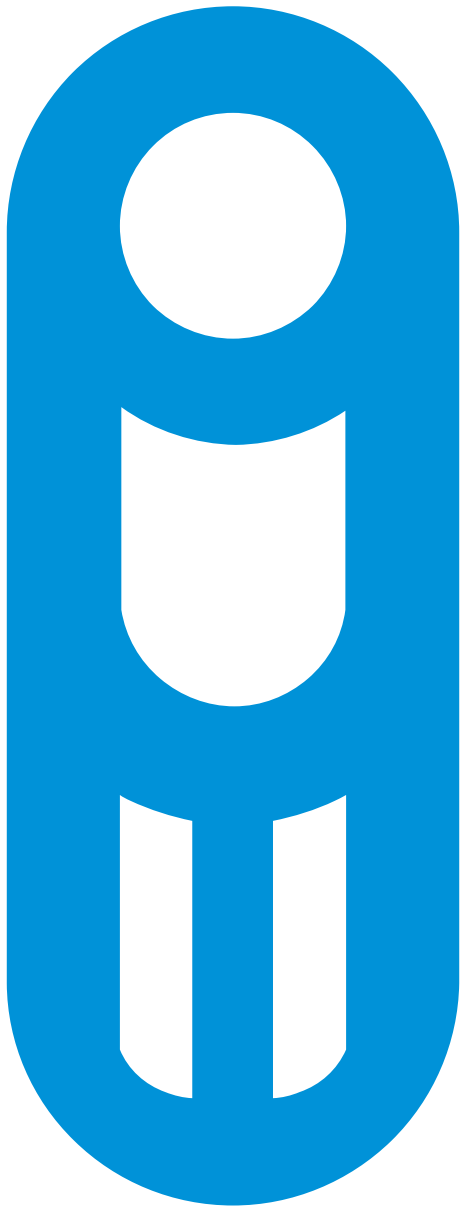



# BIRD CONTROL

## ANTI-INTRUSION SYSTEMS

### POLYETHYLENE NETS

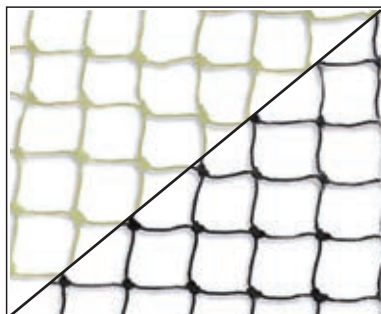

#### A 19 MM MESH NET

Knotted anti-intrusion net made of UV-treated polyethylene, with 19 mm mesh suitable for protection against sparrows. Its special stranded threads (12/6) ensure excellent resistance to tensile stress. The net is easy to install and is particularly recommended to close windows, openings, etc., creating a safe barrier from the intrusion of sparrows.

Available in two colours (stone and black) and in various sizes to facilitate the installer's work.

##### TECHNICAL DATA

Material: UV-treated polyethylene  
 Kind: Twisted twine 6 strands thick (12/6)  
 Mesh size: 19 mm

#### STONE

Code:	Dimensions:	Pack:	Pallet:
3341	5 x 5 m	25 m <sup>2</sup>	---
3345	10 x 10 m	100 m <sup>2</sup>	---
3348	15 x 15 m	225 m <sup>2</sup>	---
3351	20 x 20 m	400 m <sup>2</sup>	---
3358SM	Cut to size	---	---
3358SMEX*	Cut to size out of standard > 20 m	---	---

#### BLACK

Code:	Dimensions:	Pack:	Pallet:
4441	5 x 5 m	25 m <sup>2</sup>	---
4445	10 x 10 m	100 m <sup>2</sup>	---
4448	15 x 15 m	225 m <sup>2</sup>	---
4451	20 x 20 m	400 m <sup>2</sup>	---
4458SM	Cut to size	---	---
4458SMEX*	Cut to size out of standard > 20 m	---	---

\* Cut to size with one side larger than 20 m are out of standard

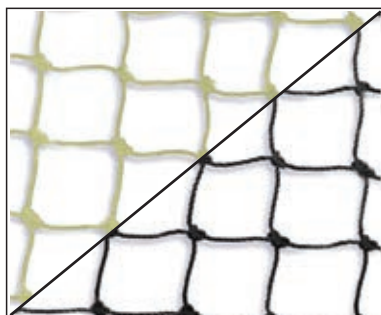

#### B 28 MM MESH NET

Knotted anti-intrusion net made of UV-treated polyethylene, with 28 mm mesh suitable for protection against starlings. Its special stranded threads (12/6) ensure excellent resistance to tensile stress. The net is easy to install and is particularly recommended to close windows, openings, etc., creating a safe barrier from the intrusion of starlings.

Available in two colours (stone and black) and in various sizes to facilitate the installer's work.

##### TECHNICAL DATA

Material: UV-treated polyethylene  
 Kind: Twisted twine 6 strands thick (12/6)  
 Mesh size: 28 mm

#### STONE

Code:	Dimensions:	Pack:	Pallet:
5541	5 x 5 m	25 m <sup>2</sup>	---
5545	10 x 10 m	100 m <sup>2</sup>	---
5548	15 x 15 m	225 m <sup>2</sup>	---
5551	20 x 20 m	400 m <sup>2</sup>	---
5558SM	Cut to size	---	---
5558SMEX*	Cut to size out of standard > 20 m	---	---

#### BLACK

Code:	Dimensions:	Pack:	Pallet:
6641	5 x 5 m	25 m <sup>2</sup>	---
6645	10 x 10 m	100 m <sup>2</sup>	---
6648	15 x 15 m	225 m <sup>2</sup>	---
6651	20 x 20 m	400 m <sup>2</sup>	---
6658SM	Cut to size	---	---
6658SMEX*	Cut to size out of standard > 20 m	---	---

\* Cut to size with one side larger than 20 m are out of standard



# BIRD CONTROL

## ANTI-INTRUSION SYSTEMS

### POLYETHYLENE NETS

#### A 50 MM MESH NET

Knotted anti-intrusion net made of UV-treated polyethylene, with 50 mm x 50 mm mesh, suitable for protection against pigeons. Its special stranded threads (12/6) ensure excellent resistance to tensile stress. The net is easy to install and is particularly recommended to close windows, openings, etc., creating a safe and practically invisible barrier from the intrusion of pigeons. Available in two colours (stone and black) and in various sizes to facilitate the installer's work.

#### TECHNICAL DATA

Material: UV-treated polyethylene  
 Kind: Twisted twine 6 strands thick (12/6)  
 Mesh size: 50 mm

STONE			
Code:	Dimensions:	Pack:	Pallet:
7741	5 x 5 m	25 m <sup>2</sup>	---
7742	5 x 10 m	50 m <sup>2</sup>	---
7743	5 x 15 m	75 m <sup>2</sup>	---
7744	5 x 20 m	100 m <sup>2</sup>	---
7745	10 x 10 m	100 m <sup>2</sup>	---
7746	10 x 15 m	150 m <sup>2</sup>	---
7747	10 x 20 m	200 m <sup>2</sup>	---
7748	15 x 15 m	225 m <sup>2</sup>	---
7749	15 x 20 m	300 m <sup>2</sup>	---
7750	15 x 25 m	375 m <sup>2</sup>	---
7751	20 x 20 m	400 m <sup>2</sup>	---
7752	20 x 25 m	500 m <sup>2</sup>	---
7753	25 x 30 m	750 m <sup>2</sup>	---
7754	30 x 30 m	900 m <sup>2</sup>	---
7755	25 x 25 m	625 m <sup>2</sup>	---
7756	20 x 30 m	600 m <sup>2</sup>	---
7758SM	Cut to size	---	---
7758SMEX*	Cut to size out of standard > 30 m	---	---

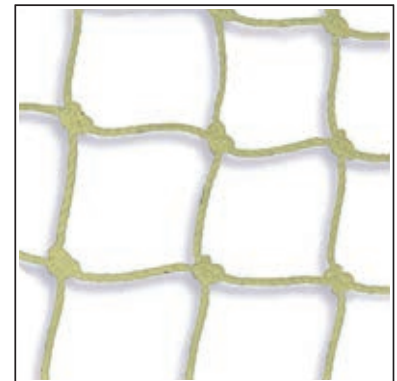

BLACK			
Code:	Dimensions:	Pack:	Pallet:
8841	5 x 5 m	25 m <sup>2</sup>	---
8842	5 x 10 m	50 m <sup>2</sup>	---
8843	5 x 15 m	75 m <sup>2</sup>	---
8844	5 x 20 m	100 m <sup>2</sup>	---
8845	10 x 10 m	100 m <sup>2</sup>	---
8846	10 x 15 m	150 m <sup>2</sup>	---
8847	10 x 20 m	200 m <sup>2</sup>	---
8848	15 x 15 m	225 m <sup>2</sup>	---
8849	15 x 20 m	300 m <sup>2</sup>	---
8850	15 x 25 m	375 m <sup>2</sup>	---
8851	20 x 20 m	400 m <sup>2</sup>	---
8852	20 x 25 m	500 m <sup>2</sup>	---
8853	25 x 30 m	750 m <sup>2</sup>	---
8854	30 x 30 m	900 m <sup>2</sup>	---
8855	25 x 25 m	625 m <sup>2</sup>	---
8856	20 x 30 m	600 m <sup>2</sup>	---
8858SM	Cut to size	---	---
8858SMEX*	Cut to size out of standard > 30 m	---	---



\* Cut to size with one side larger than 30 m are out of standard

# BIRD CONTROL

## ANTI-INTRUSION SYSTEMS

### POLYETHYLENE NETS

#### TECHNICAL DATA SHEET 50 MM NET

##### PIGEON CONTROL NET 12/6 UV-TREATED POLYETHYLENE

Mesh size:	50 mm
Weight:	21.4 g/mq
Colour:	Black/stone
Knot breaking strength:	> 10 kg
Tensile breaking strength:	> 15%
Maximum working temperature:	85°C
UV protection:	2% 540 kLy
Fire protection:	5% GP flame retardant UNI 9174 (class 1 ITA)
Maximum breaking load:	40 kg/mq

##### CORD 12/6 UV-TREATED POLYETHYLENE

Material:	High density polyethylene HDPE + 2% UV + 5% GP
Length/weight ratio:	2283 m/kg
Weight per m <sup>2</sup> :	22 g
Twists:	190 twists/m ±10%
Diameter:	1 mm ±8%
Breaking strength:	> 12 kg
Elongation:	> 150%
Tenacity:	> 3 g/den



### NYLON NETS

#### A 50 MM TRANSPARENT KNOTTED NET

Knotted anti-intrusion net made of nylon, with 50 mm x 50 mm mesh. The net is easy to install and particularly recommended to close windows, openings, etc., creating a practically invisible barrier from the intrusion of pigeons. Available in 10 x 10 metre pieces (100 m<sup>2</sup>).

##### TECHNICAL DATA

Material:	Nylon
Colour:	Transparent
Mesh:	50 mm
Dimensions:	10 x 10 m



Code:	Pack:	Carton:
8945	100 m <sup>2</sup>	---

# BIRD CONTROL

## ANTI-INTRUSION SYSTEMS

### METAL NETS

#### A COPPER EXPANDED NET

Diamond anti-intrusion net made from copper expanded mesh, this net has a pleasant visual impact. Particularly suitable for the protection of chimneys, small openings, etc. Available only in 1x10 metre rolls.

##### TECHNICAL DATA

Material: Copper  
Thickness: 1 mm  
Mesh: 14 mm diamond shaped  
Dimensions: 1 x 10 m

Code:	Pack:	Carton:
9771	10 m <sup>2</sup>	---



#### B STAINLESS STEEL EXPANDED NET

Diamond anti-intrusion net made from stainless steel expanded mesh. It has the same characteristics as the copper expanded net, but it is harder owing to the quality of stainless steel.

##### TECHNICAL DATA

Material: Stainless steel  
Thickness: 1 mm  
Mesh: 14 mm diamond shaped  
Dimensions: 1 x 10 m

Code:	Pack:	Carton:
9772	10 m <sup>2</sup>	---

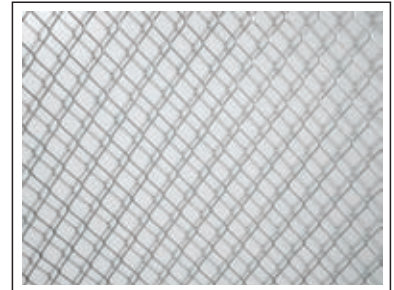



**BEFORE**



**AFTER**

# BUDDYSUN®

BUDDYSUN® IS THE INNOVATIVE BIRD BARRIER SYSTEM FOR SOLAR AND PHOTOVOLTAIC PANELS

The roofs of houses are often a popular gathering place for pigeons attracted by the heat that escapes through the roofing and chimneys.

When the roof is fitted with a solar panel system, the release of heat built up by the panels thanks to solar radiation is even higher.

As a result, pigeons tend to rest on the warm surface of the solar panels during the day, as well as sleeping below them at night.

Their droppings are acidic, which can cause tarnishing of the glass and a rapid decline in the performance and output of the panels.

The resulting need to use aggressive and abrasive cleaning products leads to further damage to the surface of the panels, which before long become degraded and ruined.

Moreover, the nests and droppings between the panels and the roofing will eventually be washed away by rain, building up inside the gutters and creating blockages in the drain pipes with a consequent overflow of rain water.

BUDDYSUN® is the innovative and protective Ecobirds™ barrier in the fight against pigeons.

BUDDYSUN® is an indispensable barrier specifically for the quick and complete sealing of the gap between the rooftop and any solar panels which are not seamlessly attached to it.

The space between the panels and the surface of the roof offers pigeons a cosy place to nest and sleep in, giving rise to a range of problems such as the accumulation of droppings, the presence of pigeon insect pests, pathogenic viruses, blocked gutters, etc.

Used with the specially designed product "Buddytape", a bi-adhesive tape with high levels of resistance to atmospheric conditions, fluctuations in temperature, water, snow and smog, installation of the BUDDYSUN® barrier does not require the panel frames to be drilled.

Once put into place and adjusted correctly, it will close off every point of entry for pigeons. It is quick and safe to install, and does not require the modification or drilling of any structural parts of the panels.

Thanks to its special shape and material (8/10 aluminium), it adapts to all panel shapes and to different roof undulations, leaving the solar system performance unaltered.

The barrier is made from painted aluminium with features which allow it to be used on all types of solar panels and roofing, without affecting the performance and output of the system.

The particular slots and holes of the BUDDYSUN® barrier are an integral and fundamental part of the product, as they allow optimal air circulation beneath the panels.

The research carried out in this regard has enabled an area equal to 25% of the total surface area to be devoted to aeration.

Attachment with the special bi-adhesive Buddytape makes the product simple and remarkably quick to install, with significant savings on manpower.

BUDDYSUN® comes in practical strips of 1 metre in length (3.28 ft), which are easy to adjust even without the use of special tools and are ideal for sealing gaps of up to 22 cm (8.66 in) in height.

**ITALIAN PATENT**

**VISIT** [buddysun.eu](http://buddysun.eu)



# BIRD CONTROL

## ANTI-INTRUSION SYSTEMS

### BUDDYSUN®

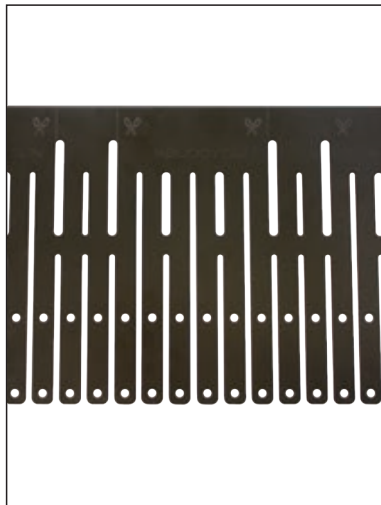

★TOP PRODUCT



#### A BUDDYSUN® – BIRD BARRIER FOR SOLAR PANELS

BUDDYSUN® is the innovative Ecobirds system, specifically designed to protect the area between the roof and the photovoltaic / solar panels installed on the top of it.

It prevents birds from accessing and building nests under the panels. It has a special shape that easily adapts to the different undulations of roofs.

BUDDYSUN® comes in practical strips of 1 metre in length, which are easy to adjust even without the use of special tools and are ideal for sealing gaps of up to 22 cm in height.

Attachment with the special bi-adhesive BUDDYTAPE makes the product simple and remarkably quick to install, with significant savings on manpower.

##### BUDDYSUN TECHNICAL DATA

Material: Aluminium  
Dimensions: 1008 x 220 mm  
Colour: Dark brown

Code:	Pack:	Pallet:
801	25 mt / pack	---



#### B BUDDYTAPE – DOUBLE-SIDED TAPE

Specific aluminium-to-aluminium bi-adhesive tape, resistant to atmospheric conditions and with high tenacity levels for heavy-duty use in outdoor environments.

##### TECHNICAL DATA

Material: Double-sided acrylic foam  
Width: 25 mm  
Thickness: 1,2 mm  
Colour: Charcoal grey  
Outstanding wide temperature range resistance  
Efficient up to 90°C  
Resistant to humidity and water  
UV resistant  
Adhesion: 40% after 2 minutes  
Maximum polymerisation: 100% after 72 hours (with an average temperature of 20°C)

Code:	Pack:	Carton:
805-6	6 mt / pack	---
805-10	10 mt / pack	---
805-15	15 mt / pack	---

# BIRD CONTROL

## ANTI-INTRUSION SYSTEMS

### BUDDYSUN®

#### A BUDDYFIX

The BUDDYFIX clip has been specifically designed to anchor the BUDDYSUN barrier to the frame of photovoltaic panels. Sometimes, the installer is asked to anchor the barrier in a way that allows it to be removed during maintenance. The BUDDYFIX clip enables a safe and long-lasting anchorage and allows the panels to be removed with extreme ease. The clip can be easily integrated into the lower edge of the panels' frame and keeps the barrier perfectly adherent. During installation, it's recommended to apply a small amount of silicone inside the barrier in order to guarantee a better seal in case of violent storms. The silicone is easily removable.

##### TECHNICAL DATA

Material: Polypropylene  
Colour: Black

Code:	Pack:	Carton:
800R100	10 pcs / pack	---



#### B BUDDYCLEAN

Perfumed sanitizing multi-use detergent with high-volatility. It is excellent for cleaning aluminium and glass surfaces from grease, oil, pollution, etc. It has a fast action: removes immediately all traces of dirt, wets out rapidly and does not need rinsing. Buddyclean is ideal for cleaning the solar panel aluminium frames and the Buddysun barrier.

##### TECHNICAL DATA

Composition: 2-Butoxyethanol  
2-Propanol  
Classification: 1272/2008 (CLP)

Code:	Pack:	Carton:
803-1000	12 pcs / pack	---

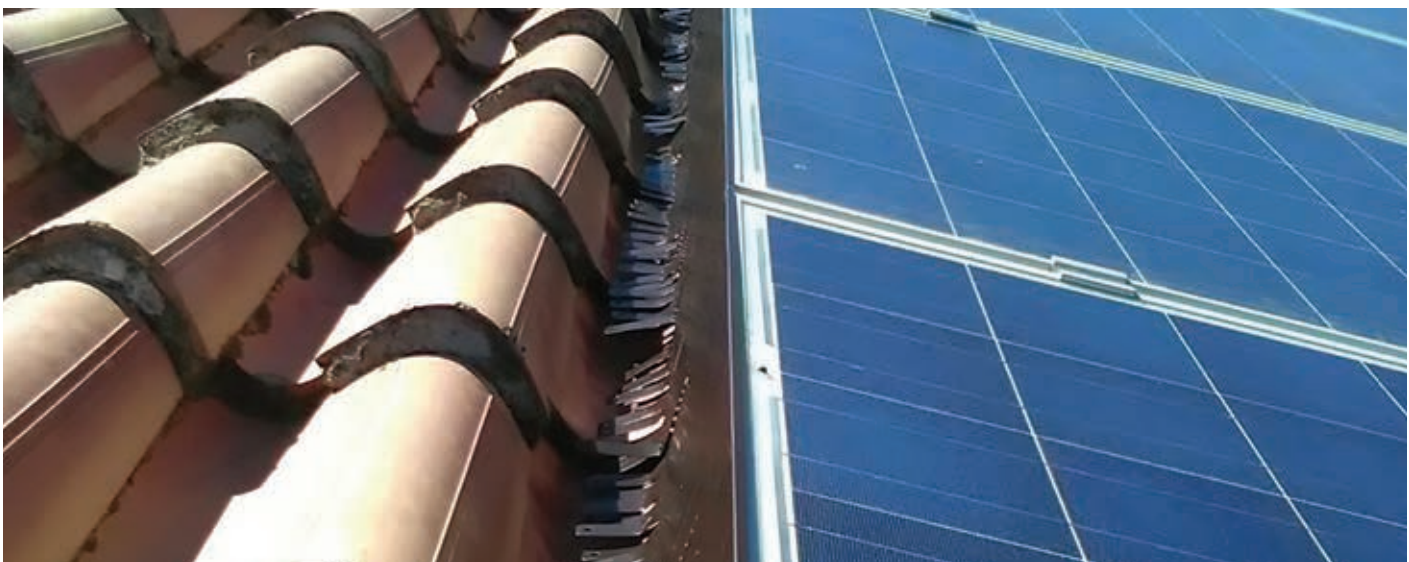

# BIRD CONTROL

## ANTI-INTRUSION SYSTEMS

### BARRIERS

#### **A** BIRD BARRIER FOR PANTILES

Ornamental bird deterrents designed to protect roofs.

Placed at the entrance of pantiles, they prevent birds from accessing and building nests under the roof.

These bird deterrents offer aesthetically pleasing solutions.

They can be fastened using self-drilling screws, self-tapping screws, etc. or simply inserted under the pantiles.

They can also be used to secure the pantiles of some roofs.

#### TECHNICAL DATA

Dimensions: 150 x 85 x h 107 mm



#### COPPER

Code:	Width:	Pack:	Carton:
810	0.4 mm	100 pcs / pack	---



#### DARK BROWN PREPAINTED SHEET IRON

Code:	Width:	Pack:	Carton:
812	0.4 mm	100 pcs / pack	---





# BIRD CONTROL

## ANTI-INTRUSION SYSTEMS

### BARRIERS

#### A BIRD BARRIER FOR TILES

Ornamental bird deterrents designed to protect roofs.

Placed at the edge of the first tiles, they prevent birds from accessing and building nests under the roof.

These bird deterrents offer aesthetically pleasing solutions.

They can be fastened using self-drilling screws, self-tapping screws, etc. or simply inserted under the tiles.

They can also be used to secure the tiles of some roofs.

#### TECHNICAL DATA

Dimensions: 150 x 85 x h 92 mm

#### COPPER

Code:	Width:	Pack:	Carton:
814	0.4 mm	100 pcs / pack	---



#### DARK BROWN PREPAINTED SHEET IRON

Code:	Width:	Pack:	Carton:
816	0.4 mm	100 pcs / pack	---



#### C PLASTIC BIRD BARRIER FOR ROOFS

Bird deterrents made of polypropylene, designed to protect roofs. Placed at the entrance of the first tiles/pantiles, they prevent birds from accessing and building nests under the roof. They can be fastened using self-drilling screws, self-tapping screws, etc. or simply inserted under the tiles/pantiles.

#### TECHNICAL DATA

Material: UV-treated polypropylene  
Width: 2 mm  
Dimensions: 142 x 95 x h 95 mm  
Colour: Reddish brown

Code:	Pack:	Carton:
818	100 pcs / pack	---



# BIRD CONTROL

## ACCESSORIES

### TECHNICAL COMPONENTS



#### A HOG RINGS TO FASTEN NET/WIRE

Hog rings used to fasten the meshes of the net to the steel wire. Specially designed to offer excellent anchorage, they are also particularly economical since they speed up installation time used with the special stapler (mod 40).



Code:	Material:	Pack:	Carton:
41	Stainless steel	2500 pcs / pack	50000 pcs / ct
42	★TOP PRODUCT Galvanised steel	2500 pcs / pack	50000 pcs / ct
43	Aluminium	2500 pcs / pack	50000 pcs / ct



#### B STAINLESS STEEL 1 MM WIRE

Fastened on strong points with eye bolt anchors, it creates a perimeter along which the net is anchored to by means of hog rings. Ideal for closure of windows, small openings, etc. 49 strands (7 x 7)

##### TECHNICAL DATA

Material: Stainless steel  
Diameter: 1 mm



Code:	Pack:	Carton:
71	100 m / pack	---



#### C 2 MM WIRE

Fastened on strong points with eye bolt anchors, it creates a perimeter along which the net is anchored to by means of hog rings. Ideal for closure of windows, small openings, etc. 49 strands (7 x 7)

##### TECHNICAL DATA

Diameter: 2 mm



Code:	Material:	Pack:	Carton:
73	★TOP PRODUCT Stainless steel	100 m / pack	---
77	Galvanised steel	100 m / pack	---



★TOP PRODUCT



#### D ALUMINIUM FERRULES FOR 2 MM WIRE

Ferrules used to crimp wire ends. Specially designed to fasten looped 2 mm wire ends, the ferrules provide quick anchorage and very little visual impact. The use of a special crimping tool - such as mod. 60 or mod. 60C - is required to compress the ferrules properly.

##### TECHNICAL DATA

Material: Aluminium  
Diameter: 2.5 mm  
Length: 8 mm



Code:	Pack:	Carton:
11	100 pcs / pack	---

# BIRD CONTROL

## ACCESSORIES

### TECHNICAL COMPONENTS

#### A COPPER FERRULES FOR 0.9 MM WIRE

Ferrules used to crimp wire ends. Specially designed to loop and fasten 0.9 mm wire, the ferrules provide quick anchorage and very little visual impact. The use of a special crimping tool - such as mod. 60B - is required to compress the ferrules properly.

##### TECHNICAL DATA

Material: Copper  
Diameter: 1 mm  
Length: 5 mm

Code:	Pack:	Carton:
12	100 pcs / pack	---



#### B COPPER FERRULES FOR 2 MM WIRE

Ferrules used to crimp wire ends. Specially designed to fasten looped 2 mm wire ends, the ferrules provide quick anchorage and very little visual impact. The use of a special crimping tool - such as mod. 60 or mod. 60C - is required to compress the ferrules properly.

##### TECHNICAL DATA

Material: Copper  
Diameter: 2.5 mm  
Length: 8 mm



Code:	Pack:	Carton:
13	100 pcs / pack	---



#### C 2 MM WIRE CLIPS

Stainless steel wire clips for 2 mm diameter wire to be used as an alternative to mod. 11-13 ferrules. Though they are more noticeable compared to the ferrules, they offer secure fastening for long lengths of wire.

##### TECHNICAL DATA

Diameter: 3 mm



Code:	Material:	Pack:	Carton:
21	Stainless steel	10 pcs / pack	---
22	Galvanized steel	10 pcs / pack	---



#### D STAINLESS STEEL EYE AND HOOK TURNBUCKLE

Stainless steel turnbuckle used to adjust the tension of the steel wire.

##### TECHNICAL DATA

Material: Stainless steel

Code:	Diameter:	Max expan. length:	Pack:	Carton:
31	M4	40 mm	5 pcs / pack	---
32 ★TOP PRODUCT	M5	55 mm	5 pcs / pack	---
33	M6	67 mm	5 pcs / pack	---

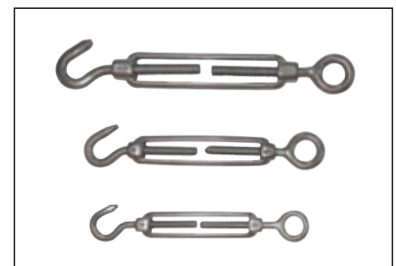

# BIRD CONTROL

## ACCESSORIES

### TECHNICAL COMPONENTS

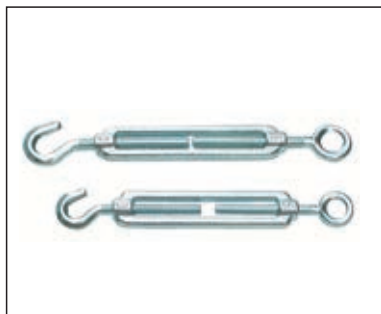

#### A GALVANISED STEEL EYE AND HOOK TURNBUCKLE

Galvanised steel turnbuckle used to adjust the tension of the steel wire.

##### TECHNICAL DATA

Material: Galvanised steel

Code:	Diameter:	Max expan. length:	Pack:	Carton:
35 <b>★TOP PRODUCT</b>	M5	55 mm	10 pcs / pack	---
36	M6	80 mm	10 pcs / pack	---

#### B NET INSPECTION ZIPPER

Fabric zipper with plastic slider, used to open and close net inspection points.

Zippers can be used on any type of bird net (pigeons, starlings, sparrows).

The zipper is fastened to the net with the hog rings normally used to secure the net to the steel wire. It is not advisable to use aluminium hog rings, which are not strong enough to perforate the zipper's cloth. Perfect for the creation of doors and quick access points.

##### TECHNICAL DATA

Material: Fabric + plastic



##### STONE

Code:	Length:	Pack:	Carton:
ZIP50	500 mm	1 pc / pack	---
ZIP100	1000 mm	1 pc / pack	---
ZIP150	1500 mm	1 pc / pack	---
ZIP200	2000 mm	1 pc / pack	---



##### BLACK

Code:	Length:	Pack:	Carton:
ZIP50N	500 mm	1 pc / pack	---
ZIP100N	1000 mm	1 pc / pack	---
ZIP150N	1500 mm	1 pc / pack	---
ZIP200N	2000 mm	1 pc / pack	---

# BIRD CONTROL

## ACCESSORIES

### FIXING COMPONENTS

#### A STAINLESS STEEL HOOKS FOR NETTING

The ideal solution to create inspection or maintenance doors/windows in nets. Thanks to its special hook, it guarantees a fast opening/closing of the net breach.

##### TECHNICAL DATA

Material: Stainless steel  
Wire diameter: 1.5 mm

Code:	Length:	Pack:	Carton:
55	50 mm	100 pcs / pack	---
57	19 mm	100 pcs / pack	---



#### B ADHESIVE CLIPS FOR NETTING

Adhesive clips ideal for use on glass and smooth surfaces. High tenacity 3M adhesive.

##### TECHNICAL DATA

Material: Aluminium

Code:	Dimensions:	Pack:	Carton:
565	20 x 10 x 4 mm	100 pcs / pack	---
566	25 x 15 x 6 mm	100 pcs / pack	---



#### C NET REPAIR TWINE

Polyethylene 12/6 twine for repairing holes or sewing zips.

##### TECHNICAL DATA

Material: UV treated polyethylene 12/6 twisted twine

Code:	Color:	Pack:	Carton:
7775	Stone	100 mt / roll	---
8875	Black	100 mt / roll	---



# BIRD CONTROL

## ACCESSORIES

### FIXING COMPONENTS



#### A NYLON WALL PLUGS

Used to perfectly anchor screws to masonry walls.

##### TECHNICAL DATA

Material: Nylon

Code:	Dimensions:	Combine with:	Pack:	Carton:
401	30 x $\varnothing$ 6 mm	54	100 pcs / pack	---
402	20 x $\varnothing$ 4 mm	403	100 pcs / pack	---
406	25 x $\varnothing$ 5 mm	407	100 pcs / pack	---



#### B STAINLESS STEEL SELF-TAPPING SCREWS

Stainless steel self-tapping screws with cylinder Phillips head.

##### TECHNICAL DATA

Material: Stainless steel

Code:	Dimensions:	Combine with:	Pack:	Carton:
403	3.0 x 20 mm	402	100 pcs / pack	---
407	3.5 x 25 mm	406	100 pcs / pack	---



#### C HAMMER-IN WALL PLUGS WITH COPPER SCREW

Hammer-in screw in copper-plated stainless steel with big size washer in copper. Particularly suitable for the quick installation of copper nets. Each single piece is made up of screw, washer and wall plug.

##### TECHNICAL DATA

Material: Copper-plated stainless steel

Length: 38

Washer:  $\varnothing$  20 mm

Hole:  $\varnothing$  6 mm

mm

Code:	Pack:	Carton:
408R	100 pcs / pack	---



#### D HAMMER-IN WALL PLUGS WITH GALVANISED STEEL SCREW

Hammer-in wall plugs. They do not require a screwdriver but are directly hammered into the wall. Particularly suitable for the quick installation of metal nets, etc.

##### TECHNICAL DATA

Material: Galvanised steel + nylon

Hole:  $\varnothing$  6 mm

Code:	Length:	Pack:	Carton:
408	37 mm	100 pcs / pack	---
409	56 mm	100 pcs / pack	---

# BIRD CONTROL

## ACCESSORIES

### FIXING COMPONENTS

#### A NYLON UV-TREATED CABLE TIES

Special nylon cable ties in black colour, with a highly effective fastening system and resistant to UV rays, oils, fats and solvents in general.

##### TECHNICAL DATA

Material: Self-extinguishing nylon  
Colour: Black

Code:	Dimensions:	Pack:	Carton:
545	200 x 4.5 mm	100 pcs / pack	---
546	280 x 7.5 mm	100 pcs / pack	---
547	360 x 7.5 mm	100 pcs / pack	---



#### B CURL HOOK TO ANCHOR WIRE

Stainless steel curl hook used to anchor the steel wire perimeter that will support the net. For use on metal surfaces such as gutters, flashings, railing, beams, rolled sections, etc.

##### TECHNICAL DATA

Material: Stainless steel

Code:	Pack:	Carton:
51	100 pcs / pack	---

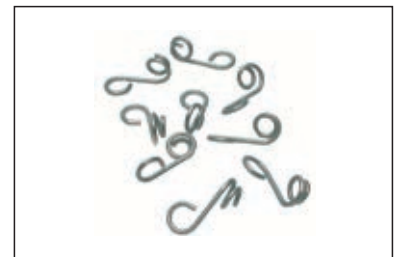

#### C STAINLESS STEEL EYE SCREW FOR WOOD/MASONRY

Stainless steel eye screw, used to anchor the steel wire perimeter that will support the net. It can be used directly on wood surfaces or on masonry surfaces together with a nylon wall plug. The flat end of the screw has a low visual impact and is resistant to tensile stress.

##### TECHNICAL DATA

Material: Stainless steel  
Length: 35 mm  
Hole diameter:  $\varnothing$  5 mm

Code:	Pack:	Carton:
54	100 pcs / pack	---



#### D STAINLESS STEEL EYE BOLT FOR WALL

High quality eye bolt used to anchor the steel wire on cement, brick, etc.

##### TECHNICAL DATA

Material: Stainless steel

Code:	Diameter:	Eyelet:	Pack:	Carton:
61	M6	$\varnothing$ 9 mm	10 pcs / pack	---
62	M8	$\varnothing$ 11 mm	10 pcs / pack	---



# BIRD CONTROL

## ACCESSORIES

### FIXING COMPONENTS



#### **A** GALVANISED STEEL EYE BOLT FOR WALL

High quality eye bolt used to anchor the steel wire on cement, brick, etc.

##### TECHNICAL DATA

Material: Galvanised steel

Code:	Diameter:	Eyelet:	Pack:	Carton:
63	M6	ø 9 mm	10 pcs / pack	---
64	M8	ø 11 mm	10 pcs / pack	---



#### **B** M3 GALVANISED STEEL EYE BOLT FOR WALL

Small eye bolt used to anchor the steel wire on cement, brick, etc.  
Fit these eye bolts between larger bolts to create intermediate anchorage points.

##### TECHNICAL DATA

Material: Galvanised steel

Diameter: M3

Eyelet: ø 6 mm

Code:	Pack:	Carton:
65	50 pcs / pack	---



#### **C** HILTI-TYPE M6 BOLTS

High quality Hilti-type galvanised steel eye/hook bolt anchor M6. Used to fix the steel wire creating the perimeter to masonry walls.

This bolt anchor is quick to install and especially indicated for reinforced concrete walls. It does not need to be screwed down, just hammered into place.

Its special lead-coated capsule provides extra strong anchorage. Use with 8 mm drill bit.

##### TECHNICAL DATA

Material: Galvanised steel

Diameter: M6

Eyelet: ø 8 mm

Code:	Shape:	Pack:	Carton:
66	Eye	100 pcs / pack	---



#### **D** SLOTTED NYLON ANCHOR RIVET

Special nylon anchor rivet with slot on upper part, used to fix the wire.

The anchor rivet is hammered into place and blocked in the wall thanks to its wings. Ideal for use on reinforced concrete walls, these anchor rivets are quick to install.

##### TECHNICAL DATA

Material: Nylon

Length: 45 mm

Diameter: ø 7 mm

Hole: 6 mm drill bit

Code:	Colour:	Pack:	Carton:
68	Grey	100 pcs / pack	---



# BIRD CONTROL

## ACCESSORIES

### FIXING COMPONENTS

#### A GALVANISED CLAMP-ON CLIPS

Specifically designed to anchor the steel wire to metal bases. These very sturdy clips are simply clamped on with the help of a hammer. Special inner wings provide the clips with excellent grip, ensuring secure anchorage and high resistance also to tensile stress. Available in 4 sizes.

##### TECHNICAL DATA

Material: Galvanised steel

Code:	Thickness:	Pack:	Carton:
555	From 1,5 to 3 mm	100 pcs / pack	---
556	From 3 to 8 mm	100 pcs / pack	---
557	From 8 to 14 mm	100 pcs / pack	---
558	From 14 to 20 mm	100 pcs / pack	---

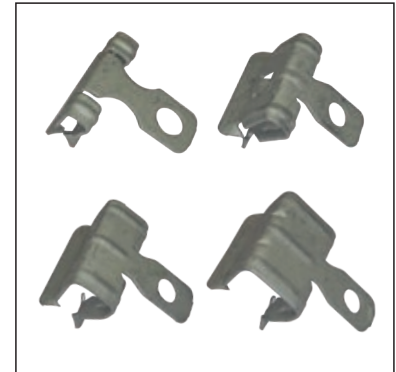

#### B SPECIAL WIRE ANCHORAGE MAGNET

Magnetic fixing Kit for anti-intrusion nets. Used to secure perimeter wire upon iron surfaces during the installation of anti-intrusion nets. The special magnet is fitted with an eye bolt and allows creating perimeter anchorage points without making holes.

##### TECHNICAL DATA

###### MAGNET

Inner material: Nickel-plated iron  
Outer material: Ferrite magnet  
Diameter: 22 mm  
Thickness: 5 mm  
Tractive force: 7 kg

###### EYE BOLT

Material: Stainless steel

Code:	Pack:	Carton:
598	10 pcs / pack	---



# BIRD CONTROL

## ACCESSORIES

### FIXING COMPONENTS



#### **A** SPECIAL STAINLESS STEEL HAMMER-IN EYE BOLT FOR WALL

Ideal to anchor the net perimeter wire on masonry walls such as reinforced concrete. It combines an extra-strong anchorage with an extremely reduced visual impact, thanks to its flat eyelet head.

##### TECHNICAL DATA

Material: Stainless steel  
Length: 60 mm  
Eyelet: ø 5 mm  
Hole: 6 mm drill bit

Code:	Pack:	Carton:
54PIN	100 pcs / pack	---



#### **B** SPECIAL GALVANISED STEEL HAMMER-IN EYE BOLT FOR WALL

Ideal to anchor the net perimeter wire on masonry walls such as reinforced concrete. It combines an extra-strong anchorage with an extremely reduced visual impact, thanks to its flat eyelet head.

##### TECHNICAL DATA

Material: Galvanised steel  
Length: 60 mm  
Eyelet: ø 5 mm  
Hole: 6 mm drill bit

Code:	Pack:	Carton:
54PZN	100 pcs / pack	---



#### **C** SPECIAL VISE TO ANCHOR NET WIRE

Ideal to anchor the net perimeter wire on IPE girders. It is adjustable to thickness ranging from 1.9 to 4.2 cm. This vise grip is ideal to fix the net wire and offers an extra-strong anchorage.

##### TECHNICAL DATA

Material: Galvanised steel  
Thickness: From 19 to 42 mm

Code:	Pack:	Carton:
599	5 pcs / pack	---

# BIRD CONTROL

## ACCESSORIES

### FIXING COMPONENTS

#### **A** SPECIAL FRAME FOR NET INSTALLATIONS

Special frames for the installation of nets around and above protruding features. The sturdy galvanised steel structure allows an extra-strong anchorage of the bird net wire at different heights. The plate at the base of the bracket has two eyelets for fixing on masonry surfaces.

#### TECHNICAL DATA

##### BRACKET

Material: Galvanised steel  
Width: 40 mm  
Thickness: 2.5 mm  
Eyelet dimensions: 30 x 9 mm

##### BASE

Material: Galvanised steel  
Length: 120 mm  
Width: 50 mm  
Thickness: 6 mm  
Fixing holes: 2  
Thickness: 2.5 mm  
Eyelet dimensions: 25 x 14 mm



Code:	Height:	Holes:	Pack:	Carton:
90	210 mm	4	20 pcs / pack	---
91	310 mm	6	20 pcs / pack	---
92	410 mm	8	20 pcs / pack	---
93	510 mm	10	20 pcs / pack	---
94	610 mm	12	20 pcs / pack	---



# BIRD CONTROL

## SOUND SCARE SYSTEMS

CONTROL UNITS ..... 60

ACCESSORIES ..... 61

## VISUAL DETERRENTS

DECOYS ..... 62

## CATCH TRAPS

CAGES ..... 63

# BIRDS





# BIRD CONTROL

## SOUND SCARE SYSTEMS

### CONTROL UNITS



#### A PROGRAMMABLE BIRD SOUND SCARE SYSTEM

This advanced sound scare system control unit can either be powered by 12V battery or electrically-powered with a 220V/12V adapter/transformer (mod. ES102). The control unit is provided with a digital programmer that operates on 220V or 12V.

The recorded distress calls of the main birds as well as predator attack cries are simultaneously used in random order. Two two-way loudspeakers (mod. ES201) or two four-way loudspeakers (mod. ES204) can be connected to the control unit with special cables (mod. ES199) at a maximum distance of 100 metres from the control unit.

The sounds are emitted for variable lengths of time (from 15 to 40 seconds) interrupted by random periods of silence lasting between 1-8 minutes.

#### TECHNICAL DATA

Wattage: 40W  
Voltage: 12V  
Loudspeakers: 0 integrated  
2 connectable  
Protection: IP65  
Solar cell: Yes



Code:	Pack:	Carton:
ES104	1 pc / pack	---



#### B BIRD SOUND SCARE SYSTEM WITH LOUDSPEAKERS

This sound scare system control unit can either be powered by 12V battery or electrically-powered with a 220V/12V adapter/transformer (mod. ES102). The control unit has two integrated two-way loudspeakers and a day/night sensor. The recorded distress calls of the main birds as well as predator attack cries are simultaneously used in random order. Besides the integrated loudspeakers, one two-way loudspeaker (mod. ES201) or one four-way loudspeaker (mod. ES204) can be connected to the control unit with special cables (mod. ES199) at a maximum distance of 100 metres from the control unit. The sounds are emitted for variable lengths of time (from 15 to 40 seconds) interrupted by random periods of silence lasting between 1-8 minutes.

A timer (mod. ES250) can otherwise be used to programme the sounds with 15-minute phases over a period of 24 hours (only for use with 220 V electricity).

#### TECHNICAL DATA

Wattage: 40W  
Voltage: 12V  
Loudspeakers: 2 integrated  
2 connectable  
Protection: IP65  
Solar cell: Yes

Code:	Pack:	Carton:
ES112	1 pc / pack	---

# BIRD CONTROL

## SOUND SCARE SYSTEMS

### ACCESSORIES

#### A TWO-WAY LOUDSPEAKERS FOR BIRD SOUND SCARE SYSTEM

Two-way loudspeakers in sturdy plastic for use with mod. ES104 sound scare systems. Can also be used as supplementary loudspeakers for mod. ES112 sound scare systems.

##### TECHNICAL DATA

Wattage: 40W  
Connectable loudspeakers: 1  
Protection: IP65



Code:	Pack:	Carton:
ES201	1 pc / pack	---



#### B FOUR-WAY LOUDSPEAKERS FOR BIRD SOUND SCARE SYSTEM

Sturdy plastic four-way loudspeakers for mod. ES100, ES112 and ES104.

##### TECHNICAL DATA

Wattage: 40W  
Connectable loudspeakers: 1  
Protection: IP65



Code:	Pack:	Carton:
ES204	1 pc / pack	---



#### C EXTENSION CABLE FOR LOUDSPEAKERS

Red/black 2-pole cable (with plugs) for the electrical connection of loudspeakers at a maximum distance of 100 metres.

##### TECHNICAL DATA

Material: 2-pole cord  
Colour: black/red  
Pack: 100 m



Code:	Pack:	Carton:
ES199	1 pc / pack	---



#### D 220V/12V TRANSFORMER FOR BIRD SOUND SCARE SYSTEM

Transformer for mod. ES112 and ES104 sound scare systems.

##### TECHNICAL DATA

Input voltage: 220V  
Output voltage: 12V



Code:	Pack:	Carton:
ES102	1 pc / pack	---



# BIRD CONTROL

## VISUAL DETERRENTS

### DECOYS



#### A HAWK DECOY

Plastic thermoformed decoy that faithfully reproduces a flying hawk.

##### TECHNICAL DATA

Material: Plastic

Code:	Pack:	Carton:
FLK350	1 pc / pack	---



#### B WINDOW DECALS - HAWKS

Black decals in various sizes.

##### TECHNICAL DATA

Material: Plastic coated paper

Colour: Black

Decals per sheet: 3

Code:	Pack:	Carton:
2372	5 pcs / pack	---





# BIRD CONTROL

## CATCH TRAPS

### CAGES

#### A CAGE FOR PIGEONS

Practical and functional cage trap used to catch pigeons. Made out of high quality galvanised steel, easy and quick to assemble, this cage trap requires little maintenance and is an essential tool when starting a pigeon capture campaign. It has one-way doors in which birds can enter but cannot get out of. Before placing traps, check the restrictions, regulations, etc. enforced in your territory. The capture of pigeons is regulated by precise territorial laws.

##### TECHNICAL DATA

Base material: Galvanised steel  
Cage material: Galvanised steel spray painted in green  
Dimensions: 1000 x 600 x 300 mm  
No. of entrances: 2

Code:	Pack:	Carton:
TZ2250	1 pc / pack	---



#### B CAGE FOR SPARROWS

Practical and functional cage trap used to catch sparrows. Made out of high quality galvanised steel, easy and quick to assemble, this cage trap requires little maintenance and is an essential tool when starting a sparrow capture campaign. The entrances are shaped so that the sparrows can enter but cannot escape. There is a door on the back of the cage to allow removal of the birds. Suitable for department stores and supermarkets.

##### TECHNICAL DATA

Material: Galvanised steel  
Dimensions: 610 x 350 x 190 mm  
No. of entrances: 2

Code:	Pack:	Carton:
TZ3334	1 pc / pack	---

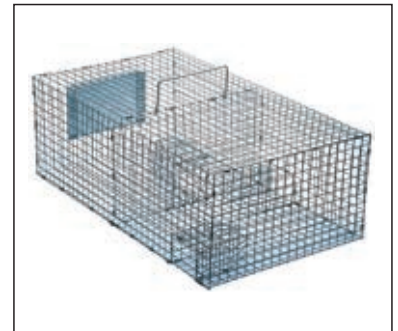

# BIRD CONTROL

## TOOLS

WORKING INSTRUMENTS ..... 66

OVIDOSE ..... 69

# ES

# BIRDS





# BIRD CONTROL

## TOOLS

### WORKING INSTRUMENTS



#### A CRIMPING PLIERS

Special crimping pliers used to correctly secure crimps (mod.131) on the stainless steel wire. Also used to cut the stainless steel wire; the pliers are in fact also designed to make accurate and clean cuts without leaving annoying burr.

##### TECHNICAL DATA

Material: Steel



Code:	Pack:	Carton:
199	1 pc / pack	---



#### B PROFESSIONAL HOG RING STAPLER

Indispensable accessory used to fix the net to the steel wire, giving installers the possibility of optimising installation time.

This handy, excellent quality tool provides secure fastening of the special hog rings (mod 41 – 42 – 43) that close into a ring around the net mesh and the wire.

##### TECHNICAL DATA

Material: Steel



Code:	Pack:	Carton:
40	1 pc / pack	---



#### C PROFESSIONAL CRIMPER

Crimping pliers used to compress mod. 11 and 13 ferrules. This top quality tool is equipped with a ratchet, which helps achieve better crimping results with the least effort.

##### TECHNICAL DATA

Material: Steel



Code:	Pack:	Carton:
60	1 pc / pack	---



#### D PROFESSIONAL WIRE CUTTER

Special high quality shears used to cleanly cut galvanised (mod 77) or stainless steel wire (mod 71-73). Suitable for wire with a diameter between 0.5 mm and 3 mm.

##### TECHNICAL DATA

Material: Steel



Code:	Pack:	Carton:
70	1 pc / pack	---

# BIRD CONTROL

## TOOLS

### WORKING INSTRUMENTS

#### A STEEL-CUTTING SHEARS FOR 3 MM STEEL RODS

Professional cutter that neatly and quickly cuts stainless steel rods mod.430. Essential, time-saving tool with excellent cutting performance.

##### TECHNICAL DATA

Material: Steel



Code:	Pack:	Carton:
435	1 pc / pack	---



#### B CRIMPING TOOL FOR CABLE TERMINALS

High quality crimping pliers for insulated cable terminals (mod 414), an essential tool used to properly fix the terminals to the high voltage cable (mod. 480). To prevent current leakage, the threaded rods must in fact be securely connected to the high voltage cable.

##### TECHNICAL DATA

Material: Steel



Code:	Pack:	Carton:
418	1 pc / pack	---



#### C SOCKET SCREWDRIVER FOR M3 NUTS

5.5 mm socket screwdriver used to correctly tighten mod. 416 nuts, which in turn are used to properly connect the high voltage cable, the cable terminals and the rods of the electric line.

##### TECHNICAL DATA

Material: Chrome-vanadium steel  
Diameter: 5.5 mm for M3 nut



Code:	Pack:	Carton:
417	1 pc / pack	---



#### D COMBINATION SPANNER FOR M3 NUTS

5.5 mm combination spanner used to correctly tighten mod. 416 nuts.

##### TECHNICAL DATA

Material: Chrome-vanadium steel  
Diameter: 5.5 mm for M3 nut



Code:	Pack:	Carton:
419	1 pc / pack	---



#### E PROFESSIONAL SHEARS FOR METAL NET

High quality shears used to cut the metal net. This tool is indispensable to cut out the required shape and size of net depending on installation needs.

##### TECHNICAL DATA

Material: Chrome-steel



Code:	Pack:	Carton:
484	1 pc / pack	---

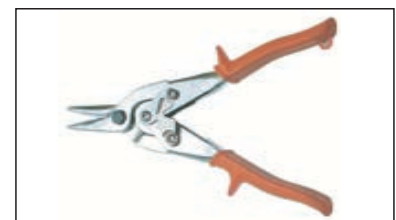

# BIRD CONTROL

## TOOLS

### WORKING INSTRUMENTS



#### A PROFESSIONAL SCISSORS

Heavy-duty electrician's scissors with straight blades.

##### TECHNICAL DATA

Material: Chrome-steel

Code:	Pack:	Carton:
483	1 pc / pack	---



#### B M3 HEX SCREWDRIVER

Hex screwdriver specifically designed to tighten stainless steel Allen screws onto mod. 490 mammoth clamps.

##### TECHNICAL DATA

Diameter: 1.5 / M3



Code:	Pack:	Carton:
491	1 pc / pack	---



#### C M4 HEX SCREWDRIVER

Hex screwdriver specifically designed to tighten stainless steel Allen screws onto mod. 413 mammoth clamps.

##### TECHNICAL DATA

Diameter: 2 / M4



Code:	Pack:	Carton:
492	1 pc / pack	---



#### D SPACER TEMPLATE FOR ELECTRIC LINE

Spacer template used to correctly position the support clamps (mod. 420) for the electric line.

##### TECHNICAL DATA

Material: Aluminium  
Length: 330 mm



Code:	Pack:	Carton:
DS001	1 pc / pack	---

**EDO BIRDS**  
LEADING BRAND IN BIRD CONTROL

# OVIDOSE

## **A** OVIDOSE - AUTOMATIC DISPENSER FOR PIGEON CONTRACEPTIVE

Efficient automatic dispenser of contraceptive grains, OVIDOSE is ideal for use in areas with no public access. OVIDOSE has a simple and easy-to-manage structure in painted steel, that feeds automatically the birds, with no need of human presence. OVIDOSE has an electric motor that drives a seed distribution plate that can spread the contraceptive grains approximately 2 metres around the dispenser. A digital timer regulates both the time of distribution and the amount of grains to be spread. The wide tank has a capacity of 15 kg and guarantees repeated daily feedings, in an automatic, programmed and efficient way. The battery is sufficient for a full season of treatment (7-9 months).

- Best results
- Reduced labour cost
- Easy maintenance

\* Each kit includes: 1 OVIDOSE dispenser fully equipped with motor, battery and battery charger.

### TECHNICAL DATA

Material: Painted steel  
 Dimensions: 80 x 40 cm  
 Empty weight: 12 Kg  
 Tank capacity: 20 litres  
 Power supply: Battery (6V)  
 Programming : Digital timer



Code:	Pack:	Carton:
OVIKIT	1 kit / pack *	---

# RODENT CONTROL

## BAIT STATIONS

METAL	72
PLASTIC	74

## CATCH TRAPS

MECHANICAL	95
GLUE TRAPS	106
CAGES	110

## ACCESSORIES

FIXING SYSTEMS	112
SPARES	118

## CUSTOMISATION

PAD PRINTING	123
--------------	-----

# RODENT







# RODENT CONTROL

## BAIT STATIONS

### METAL



#### **A** TRAPEZOID-SHAPED METAL BAIT STATION PAINTED WHITE

This bait station is the result of extensive studies and is designed to offer maximum safety, high performance, as well as an attractive design.

A disposable tray that can hold any type of bait, from grain bait to wax blocks of all sizes.

It can quickly be fixed to the floor/wall with a single anchor screw or it can be fixed to poles using the special accessory.

Its metal structure and special Allen wrench lock makes it safe in case of accidental tampering.

The inside is free from obstacles so it can easily be cleaned.

Each bait station includes an inner tray, rods to secure bait, accessories to fasten the bait station to a wall or pole, and a station identification label.

#### TECHNICAL DATA

Material: Stove-enamelled galvanised steel

Colour: White

Dimensions: 300 x 125 x h 110 mm

Code:

9480

Pack:

12 pcs / pack

Pallet:

300 pcs / pallet



# **F**ORTEZZA



**RODENT**



**T MAXI**

# RODENT CONTROL

## BAIT STATIONS

### PLASTIC



#### A TRAPEZOID-SHAPED PLASTIC BAIT STATION

Locking rat bait station, made of heavy-duty plastic (HD polypropylene). It can withstand the harshest weather conditions and is suitable for both indoor and outdoor use.

Thanks to its trapezoid shape, it has a low visual impact and can be positioned anywhere.

The key features making this product the most innovative bait station available on the market are:

- 1 - safe opening and locking with special Allen wrench
- 2 - versatile fixing system for all types of situations (included)
- 3 - adjustable entrance hole size (included)
- 4 - inner part free from obstacles for easy and fast cleaning
- 5 - internal disposable tray (included) that can safely hold any type of bait
- 6 - safe, tamper-resistant station, keeping bait away from children and pets
- 7 - identification label and rods to secure wax bait (included).

It comes with an identification label, fixing accessories for masonry wall surfaces, poles and vertical supports.

#### TECHNICAL DATA

Material: HD polypropylene  
Colour: Black  
Dimensions: 330 x 140 x h 110 mm



Code:	Pack:	Pallet:
9300	18 pcs / pack	360 pcs / pallet



#### B VERSION WITHOUT ACCESSORIES

With the same characteristics as mod. 9300 but without the fixing accessories and without the bait tray and bait securing rods.

#### TECHNICAL DATA

Material: HD polypropylene  
Colour: Black  
Dimensions: 330 x 140 x h 110 mm



Code:	Pack:	Pallet:
9301	18 pcs / pack	360 pcs / pallet



#### C VERSION WITHOUT FIXING ACCESSORIES

With the same characteristics as mod. 9300, with bait tray and bait fixing rods, but without the fixing accessories.

#### TECHNICAL DATA

Material: HD polypropylene  
Colour: Black  
Dimensions: 330 x 140 x h 110 mm



Code:	Pack:	Pallet:
9302	18 pcs / pack	360 pcs / pallet

# T RAPEZIO

# RODENT CONTROL

## BAIT STATIONS

### PLASTIC

#### A TRAPEZOID-SHAPED PLASTIC BAIT STATION

Locking rat bait station, made of sturdy plastic (HD polypropylene), suitable only for indoor use. Thanks to its trapezoid shape, it has a low visual impact and can be positioned anywhere. The key features making this product the most innovative bait station available on the market are:

- 1 - safe opening and locking with special Allen key
- 2 - versatile fixing system for all types of situations (included)
- 3 - adjustable entrance hole size (included)
- 4 - inner part free from obstacles for easy and fast cleaning
- 5 - internal disposable tray (included) that can safely hold any type of bait
- 6 - complies with safety standards and does not allow children and pets to reach or touch the rodent bait
- 7 - can lodge mod. 9570/9575 glue trays when the use of poison is prohibited
- 8 - station identification label and pins to secure wax bait (included).

It is supplied with an identification label, fixing accessories for masonry wall surfaces, poles and vertical supports.



#### TECHNICAL DATA

Material: HD polypropylene  
Colour: Transparent  
Dimensions: 330 x 140 x h 110 mm



Code:	Pack:	Pallet:
9305	18 pcs / pack	360 pcs / pallet

#### B VERSION WITHOUT ACCESSORIES

With the same characteristics as mod. 9305 but without the fixing accessories and without the bait tray and bait securing rods.

#### TECHNICAL DATA

Material: HD polypropylene  
Colour: Transparent  
Dimensions: 330 x 140 x h 110 mm



Code:	Pack:	Pallet:
9306	18 pcs / pack	360 pcs / pallet

#### C VERSION WITHOUT FIXING ACCESSORIES

With the same characteristics as mod. 9305, with bait tray and bait securing rods, but without the fixing accessories.

#### TECHNICAL DATA

Material: HD polypropylene  
Colour: Transparent  
Dimensions: 330 x 140 x h 110 mm



Code:	Pack:	Pallet:
9307	18 pcs / pack	360 pcs / pallet

# T RAPEZIO EC

ECO RODENT

75

# RODENT CONTROL

## BAIT STATIONS

### PLASTIC



## T MAXI

### A T-SHAPED BAIT STATION

Rodenticide bait dispenser with a new design and a dedicated key for safety locking. Its inverted 'T' shape allows an optimised consumption of the bait, which is added from the top of the station. Thanks to its peculiar shape, this station can be placed anywhere, on walls, fences, posts, etc. TMAXI is equipped with a specific tube and an L-shaped rod for holding the rodenticide block. The side openings allow entry even to large rats, giving them comfortable space to feed. Two partitions tactically positioned on the side of the bait tube prevent any possible accidental contact. Mod 9810T can be customised with your company logo using pad-printing (mod 9810TP)

#### TECHNICAL DATA

Material: HD polypropylene  
Colour: Grey  
Dimensions: 290 x h 300 x ø 70 mm

Code:	Pack:	Pallet:
9810T	12 pcs / pack	360 pcs / pallet



## T MAXI EC

### B T-SHAPED BAIT STATION - EASY CHECK

TMAXI EC is the Easy Check version of mod 9810T. It has a transparent front section for easy inspection and checking bait consumption. It can be customised with your company logo using pad-printing (mod 9815TP)

#### TECHNICAL DATA

Material: HD polypropylene  
Colour: Grey + transparent  
Dimensions: 290 x h 300 x ø 70 mm

Code:	Pack:	Pallet:
9815T	12 pcs / pack	360 pcs / pallet



## T MAXI

Installation video

# RODENT CONTROL

## BAIT STATIONS

### PLASTIC

#### **T MINI**

##### **A** T-SHAPED BAIT STATION - GREY

Made of sturdy grey plastic and shaped like an upside down "T", this innovative bait station is designed for outdoor use, has a key and is used to safely hold rodent bait. The T-shape design, although large and spacious, means it can be strategically and unobtrusively positioned, preventing it from being accidentally knocked. Mod 2250T features a lock and a special key which increases safety, preventing accidental contact with the rodent poison. Mod 2250T is ideal for rodent control in town centres and public and crowded places, but can also be used in the food industry, as well as on farms, landfills, camp sites, and in railway stations and ports.

Mod 2250T can be customised with your company logo using pad-printing (mod 2250TP).

#### TECHNICAL DATA

Material: Polypropylene  
Colour: Grey  
Dimensions: 245 x h 275 x ø 60 mm

Code:	Pack:	Pallet:
2250T	24 pcs / pack	672 pcs / pallet



#### **T MINI EC**

##### **B** T-SHAPED BAIT STATION – EASY CHECK

Made of sturdy plastic and shaped like an upside down "T", this innovative bait station is designed for indoor use, has a key and is used to safely hold rodent bait. The front part is made of transparent plastic with a clear translucent inspection window, which makes it easy to check the quantity of bait left in the station. The T-shape design, although large and spacious, means it can be strategically and unobtrusively positioned, preventing it from being accidentally knocked. Mod 2255T features a lock and a special key which increases safety, preventing accidental contact with the rodent poison.

Mod 2255T can be customised with your company logo using pad-printing (mod 2255TP).

#### TECHNICAL DATA

Material: Polypropylene  
Colour: Grey + transparent  
Dimensions: 245 x h 275 x ø 60 mm

Code:	Pack:	Pallet:
2255T	24 pcs / pack	672 pcs / pallet



Installation video

# RODENT CONTROL

## BAIT STATIONS INSTALLATION TIPS

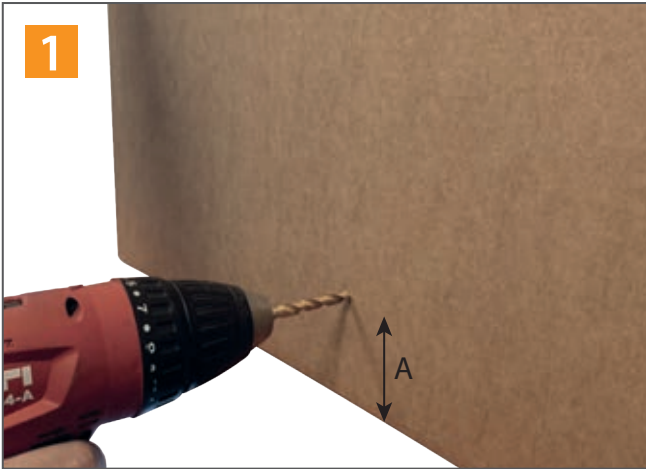

1 Drill a 6 mm hole in the wall, at 3-4 cm from the ground (for the lowest back slot) or at 7-8 cm for the highest back slot (A).

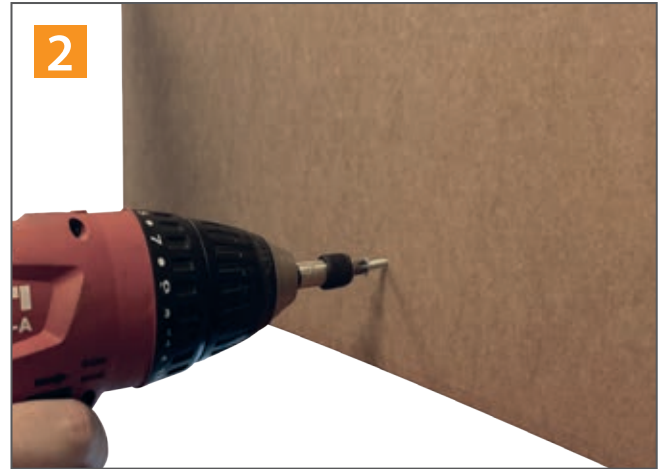

2 Insert a 6 mm nylon plug and a screw into the hole.

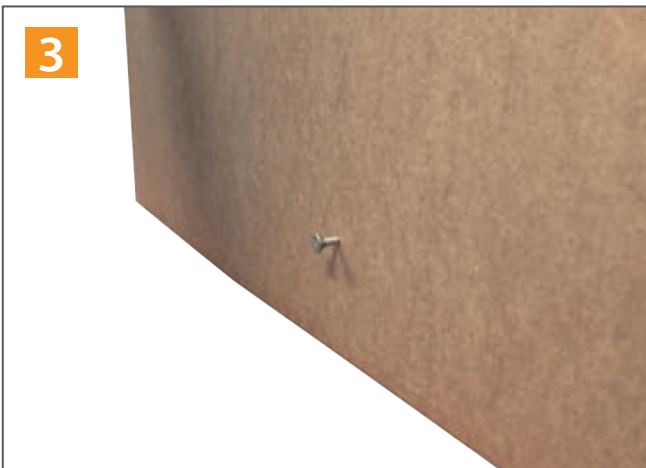

3 Do not screw it completely, but leave it approx 5 mm out of the wall.



4 Insert the screw head in the lowest or highest slot on the back of the T-shaped bait station, and push it down.

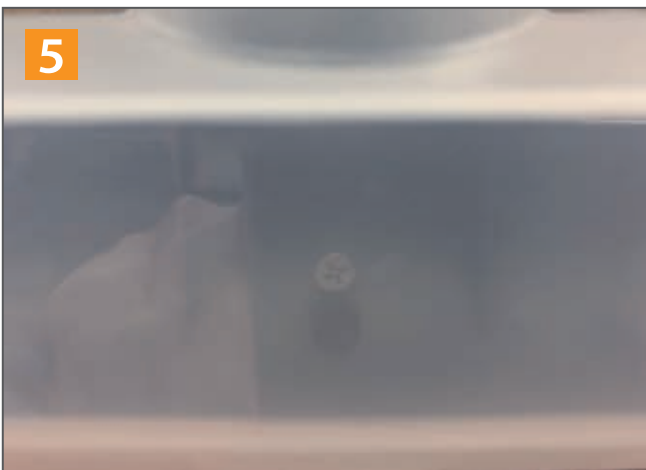

5 Detail of the screw head position in the back slot.



6 Drill a 6 mm hole in correspondence of the highest slot of the station, insert a 6 mm nylon plug and a screw into the hole.



# RODENT CONTROL

## BAIT STATIONS INSTALLATION TIPS



Do not screw it completely, but leave it approx 5 mm out of the wall.



Detail of the screw head position in the back slot.



Apply the cap and lock it with the key; the bait station is now safely locked to the wall and can be taken away only by removing the cap.



### **A** ELASTIC FIXING CLAMP FOR T-SHAPED BAIT STATIONS

Special elastic clamp, used to fix T-shaped bait stations to the wall. This special fixing clamp is especially suitable for use in narrow places and when frequent maintenance is required. The clamp-fitted bait station can in fact be quickly removed by personnel and just as quickly replaced after maintenance.

Please note: this clamp is not supplied with the bait station and must be ordered separately.

#### TECHNICAL DATA

Material: Polypropylene

Code:	Pack:	Pallet:
9845	15 pcs / pack	---



# MULTIFUNCTIONAL STATION

## RODENTS AND CRAWLING INSECTS TRAP



The station, equipped with two lodgings for glue boards, enables the simultaneous and independent control of both rodents and insects.

A specific glue board for rodent control can be lodged on the partition tray, while underneath the same tray a glue board allows the monitoring and checking of crawling insects.

## TRAP AND BAIT STATION FOR RODENTS AND CRAWLING INSECTS



The partition tray has been specifically designed to lodge either a rodenticide bait, anchored with a rod, or a snap trap, visible from the outside through the transparent lid.



# RODENT CONTROL

## BAIT STATIONS

### PLASTIC

#### **B** IBOX EVO

##### **A** MULTIFUNCTIONAL BAIT STATION

BIBOX EVO is a new-concept rodent bait station entirely made of sturdy plastic. A cardboard glue trap can be placed inside the special compartment to simultaneously monitor crawling insects. The specific lid with bump allows to position, above the tray, a snap trap to comply with the increasing requests for animal welfare protection. Thanks to its easily removable bait tray and to its special quick-release fixing system, this bait station is very practical for operators to clean and to use for inspections. Rod to block wax bait, a fixing screw, wall plug and locking key are provided. Can be customised with pad printing.

##### TECHNICAL DATA

Material: HD polypropylene  
Colour: Black  
Dimensions: 210 x 145 x h 85 mm

Code:	Pack:	Pallet:
9820A	20 pcs / pack	440 pcs / pallet



NEW



#### **B** IBOX EVO EC

##### **B** MULTIFUNCTIONAL BAIT STATION - EASY CHECK

BIBOX EVO EC is the Easy Check version of mod 9820A. The lid is made of clear plastic for easy inspection.

##### TECHNICAL DATA

Material: HD polypropylene  
Colour: Black base + Transparent lid  
Dimensions: 210 x 145 x h 85 mm

Code:	Pack:	Pallet:
9825A	20 pcs / pack	440 pcs / pallet



NEW

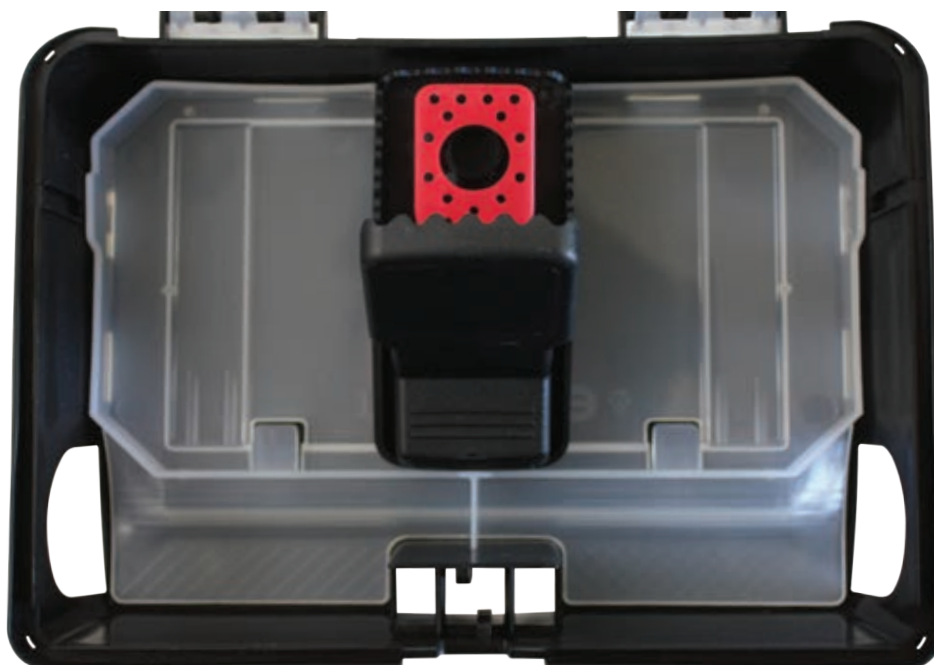

# RODENT CONTROL

## BAIT STATIONS

### PLASTIC



#### **B IBOX**

##### **A** BAIT STATION AND TRAP FOR RODENTS AND INSECTS

New-concept rodent bait station entirely made of sturdy plastic. A cardboard glue trap can be placed inside the special compartment to simultaneously monitor crawling insects. Thanks to its easily removable bait tray and to its special quick-release fixing system, this bait station is very practical for operators to clean and to use for inspections. Rod to block wax bait, a fixing screw, wall plug and locking key are provided. Can be customised with pad printing.

##### TECHNICAL DATA

Material: HD polypropylene  
Colour: Black  
Dimensions: 210 x 145 x h 65 mm



Code:

9850A

Pack:

30 pcs / pack

Pallet:

672 pcs / pallet



#### **B IBOX EC**

##### **B** BAIT STATION /TRAP FOR RODENTS AND INSECTS - EASY CHECK

New-concept rodent bait station made of sturdy plastic. It has a special compartment in which to place a cardboard glue trap to simultaneously control both rodents (with solid bait) and crawling insects. Thanks to its removable bait tray and to its special wall fixing system, this bait station is particularly practical and easy to use. It is supplied with a locking key, fixing screw, wall plug and rods to block wax bait. Can be customised with pad printing.

##### TECHNICAL DATA

Material: HD polypropylene  
Colour: Black base + transparent lid  
Dimensions: 210 x 145 x h 65 mm

Code:

9855A

Pack:

30 pcs / pack

Pallet:

672 pcs / pallet



# RODENT CONTROL

## BAIT STATIONS

### PLASTIC

#### **BOXER**

##### **A** RECTANGULAR PLASTIC BAIT STATION

Locking rodent bait station made of heavy-duty dark grey plastic (HD polypropylene). It can withstand the harshest weather conditions and is suitable for both indoor and outdoor environments. Thanks to its special shape and to the hinged lid on the short end, it can be positioned anywhere, offering a low visual impact, and it can also be easily inspected by operators.

Main features:

- 1 - opens and locks with special key
- 2 - large entrance holes
- 3 - partition dividing the inside so that any kind of bait can be safely used
- 4 - sturdy and particularly suitable for outdoor use
- 5 - can hold either rodent baits or snap traps
- 6 - can be customised with pad printing or embossed logo directly on the plastic



##### TECHNICAL DATA

Material: HD polypropylene  
Colour: Black  
Dimensions: 250 x 165 x h 105 mm



Code:	Pack:	Pallet:
9310	22 pcs / pack	528 pcs / pallet

#### **BOXER EC**

##### **B** RECTANGULAR PLASTIC BAIT STATION - EASY CHECK

Rodent bait station made of transparent heavy-duty plastic (HD polypropylene), suitable for indoor use. Thanks to its special shape and to the hinged lid on the short end, it can be positioned anywhere, offering a low visual impact, and it can also be easily inspected by operators.

Main features:

- 1 - opens and locks with special key
- 2 - large entrance holes
- 3 - partition dividing the inside so that any kind of bait can be safely used
- 4 - can hold either rodent baits or snap traps, with optional remote control
- 5 - can be customised with pad printing or embossed logo directly on the plastic during the production process.



##### TECHNICAL DATA

Material: HD polypropylene  
Colour: Transparent  
Dimensions: 250 x 165 x h 105 mm

Code:	Pack:	Pallet:
9315	22 pcs / pack	528 pcs / pallet

# WALL VERTICAL POSITIONING (code 9412)



This version of Crystal comes with a sturdy tray (code 9399) designed to facilitate the rodent's climbing up to the rodenticide bait. The tray is easily removable to make maintenance of the station fast and simple.

## RODENT AND CRAWLING INSECT BAIT STATION



The bait tray allows a safe pest control service even in a vertical position; it can lodge rodenticide bait in solid formulation, in pasta or even loose grains/pellets. Under the tray, a dedicated slot houses a special glue board for monitoring crawling insects (code HPR9533).



# RODENT CONTROL

## BAIT STATIONS

### PLASTIC

## CRYSTAL

### A RECTANGULAR PLASTIC BAIT STATION

CRYSTAL is a new rodent bait station made of heavy-duty dark grey plastic (HD polypropylene). It's shape and design allow CRYSTAL to offer maximum versatility and high performances as well as an elegant aesthetic.

This version is specific for wall vertical positioning and comes with a sturdy tray made to house rodenticide bait in solid formulation, in pasta or even loose grains/pellets.

A special glue board can be placed under the tray for the monitoring of crawling insects.

#### TECHNICAL DATA

Material: HD polypropylene  
Colour: Black  
Dimensions: 250 x 180 x 120 mm  
Holes: 2 x 60 mm diameter

Code:	Pack:	Pallet:
9412	20 pcs / pack	440 pcs / pallet

NEW



# FLOOR HORIZONTAL POSITIONING (code 9410)



The thermoformed tray provided (code 9623) has been designed and studied to allow the lodging either of rodenticide baits or of a snap trap.

## RODENT TRAP



Crystal can be used as a rodent trap by removing the provided thermoformed tray and inserting a dedicated glue tray 15 x 12.5 cm (code 9577), which is safely secured to the station thanks to specific hooking points.

As an alternative to this glue tray, to respect animal welfare a snap trap of the THOR-XL type can be lodged inside the provided thermoformed tray.





# RODENT CONTROL

## BAIT STATIONS

### PLASTIC

## CRYSTAL

### A RECTANGULAR PLASTIC BAIT STATION

CRYSTAL is a new rodent bait station made of heavy-duty dark grey plastic (HD polypropylene). Its shape and design allow CRYSTAL to offer maximum versatility and high performances as well as an elegant aesthetic.

This version is specific for floor horizontal positioning and comes with a thermoformed tray studied to allow the lodging either of rodenticide baits or of a THOR-XL snap trap to respect animal welfare. Removing the thermoformed tray allows the placing of a dedicated glue tray, which is safely secured to the station thanks to specific hooking points.

#### TECHNICAL DATA

Material: HD polypropylene  
Colour: Black  
Dimensions: 250 x 180 x 120 mm  
Holes: 2 x 60 mm diameter

Code:	Pack:	Pallet:
9410	20 pcs / pack	440 pcs / pallet



## CRYSTAL EC

### B RECTANGULAR PLASTIC BAIT STATION - EASY CHECK

CRYSTAL EC is the Easy Check version of mod 9410. The lid is made of clear plastic for easy inspection and checking bait consumption and caught rodents.

#### TECHNICAL DATA

Material: HD polypropylene  
Colour: Black base + Transparent lid  
Dimensions: 250 x 180 x 120 mm  
Holes: 2 x 60 mm diameter

Code:	Pack:	Pallet:
9415	20 pcs / pack	440 pcs / pallet



# RODENT CONTROL

## BAIT STATIONS PLASTIC



### A CELLULAR PLASTIC RODENT BAIT STATION

Practical rodent bait station made of transparent cellular plastic supplied in pre-folded die-cut sheets that are easy to assemble. It has an inner chamber in which the bait can be safely placed to prevent accidental spilling.

#### TECHNICAL DATA

Material: Cellular plastic  
Dimensions: 180 x 105 x h 55 mm  
Colour: Opaque transparent



Code:	Pack:	Pallet:
9900	50 pcs / pack	2600 pcs / pallet



### B RAT BAIT STATION IN THERMOFORMED PLASTIC

Budget bait station in thermoformed plastic for rats, it can lodge the rod for wax blocks. It is an excellent compromise between safety bait stations and economical ones. Suitable for use in wet areas.

#### TECHNICAL DATA

Material: Thermoformed plastic  
Colour: Black  
Dimensions: 245 x 170 x h 70 mm

Bait not included



Code:	Pack:	Pallet:
9870	50 pcs / pack	720 pcs / pallet



### C MOUSE BAIT STATION IN THERMOFORMED PLASTIC

Budget bait station in thermoformed plastic for *Mus musculus*, it can lodge the rod for wax blocks. It is an excellent compromise between safety bait stations and economical ones. Suitable for use in wet areas.

#### TECHNICAL DATA

Material: Thermoformed plastic  
Colour: Black  
Dimensions: 110 x 80 x h 35 mm

Bait not included



Code:	Pack:	Pallet:
9880	150 pcs / pack	5400 pcs / pallet

# RODENT CONTROL

## BAIT STATIONS

### PLASTIC

#### **P** ETIT

##### **A** HALF-MOON RODENT BAIT STATION

Rodent bait station made of polypropylene, discreet and hardly noticeable, suitable for all types of bait (wax blocks, pasta, grains, etc.). It opens and locks with the special key that is supplied.

The bait station can be connected to the mod. 9220 trap using an innovative fixing system, providing quick and simultaneous control of both rodents and insects.

The mod. 9330 bait station, placed on top of the mod. 9220 trap, closes the holder of the pheromone attractant or food lure instead of the cap that is supplied, thus providing high monitoring control at all times.

##### TECHNICAL DATA

Material: Polypropylene  
Colour: Black  
Dimensions: 170 x 100 x h 40 mm



Code:	Pack:	Pallet:
9330	12 pcs / pack	2400 pcs / pallet

#### **O** MNIBOX

##### **B** OMNIBOX RODENT AND INSECT BAIT STATION

Omnibox is the ideal bait station for the simultaneous control of small rodents and insects. It can lodge glue boards model 9520 and 9525. With its low profile, it can be easily positioned in any place. A dedicated locking key is included.

##### TECHNICAL DATA

Material: HD polypropylene  
Colour: Black  
Dimensions: 205 x 120 x 40 cm



Code:	Pack:	Pallet:
9370	20 pcs / pack	1680 pcs / pallet

#### **O** MNIBOX EC

##### **C** OMNIBOX RODENT AND INSECT BAIT STATION - EASY CHECK

Omnibox is the ideal bait station for the simultaneous control of small rodents and insects. It can lodge glue boards model 9520 and 9525. With its low profile, it can be easily positioned in any place. A dedicated locking key is included.

##### TECHNICAL DATA

Material: HD polypropylene  
Colour: Trasparent  
Dimensions: 205 x 120 x 40 cm



Code:	Pack:	Pallet:
9375	20 pcs / pack	1680 pcs / pallet

# RODENT CONTROL

## BAIT STATIONS

### PLASTIC



## ULISSE

### A MULTIFUNCTIONAL RODENT BAIT STATION

Brand new bait station, the only one of its kind on the market, it is the result of in-depth studies lasting over two years since its first prototyping. Ulisse can be used for more than one function, as it has a specific internal tray that determines the access points for rodents. The bottom consists of 5 holes on three sides and can be transformed for correct positioning either vertically against the wall or horizontally by placing it on the floor. Inside there is a specific safety tray that can hold rodenticide bait or snap traps. The tray is designed to lodge a specific glue and consequently transform the station into a glue trap. The generous size allows even large rodents to move comfortably horizontally and climb easily vertically. It can be customised with your company logo by pad printing (mod 9390P)

#### TECHNICAL DATA

Material: HD polypropylene  
Colour: Black  
Dimensions: 235 x 275 x h 105 mm

Code:	Pack:	Pallet:
9390	14 pcs / pack	308 pcs / pallet



## ULISSE EC

### B MULTIFUNCTIONAL RODENT BAIT STATION – EASY CHECK

ULISSE EC is the Easy Check version of mod 9390. The lid is made of clear plastic for easy inspection and checking bait consumption and caught rodents. It can be customised with your company logo using pad-printing (mod 9395P)

#### TECHNICAL DATA

Material: HD polypropylene  
Colour: Black + transparent  
Dimensions: 235 x 275 x h 105 mm

Code:	Pack:	Pallet:
9395	14 pcs / pack	308 pcs / pallet



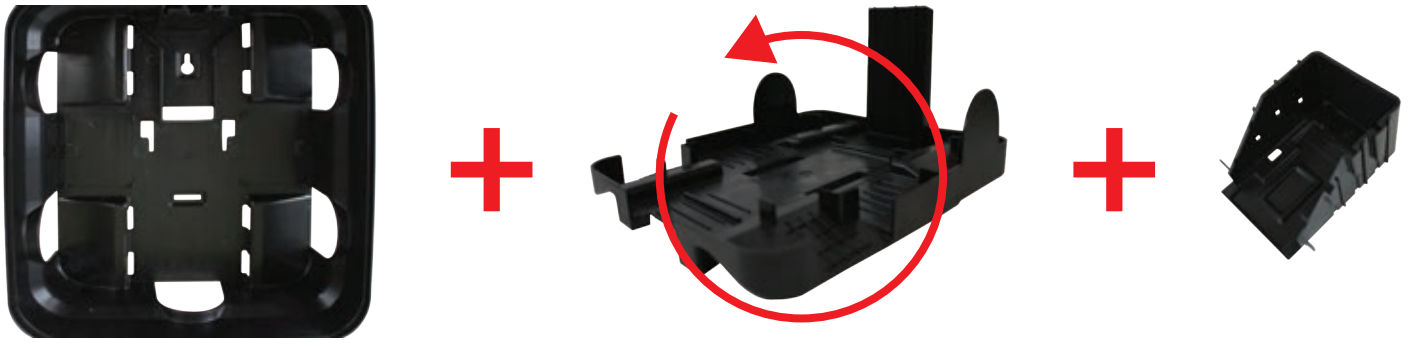

HORIZONTAL  
FLOOR POSITIONING



VERTICAL  
WALL POSITIONING

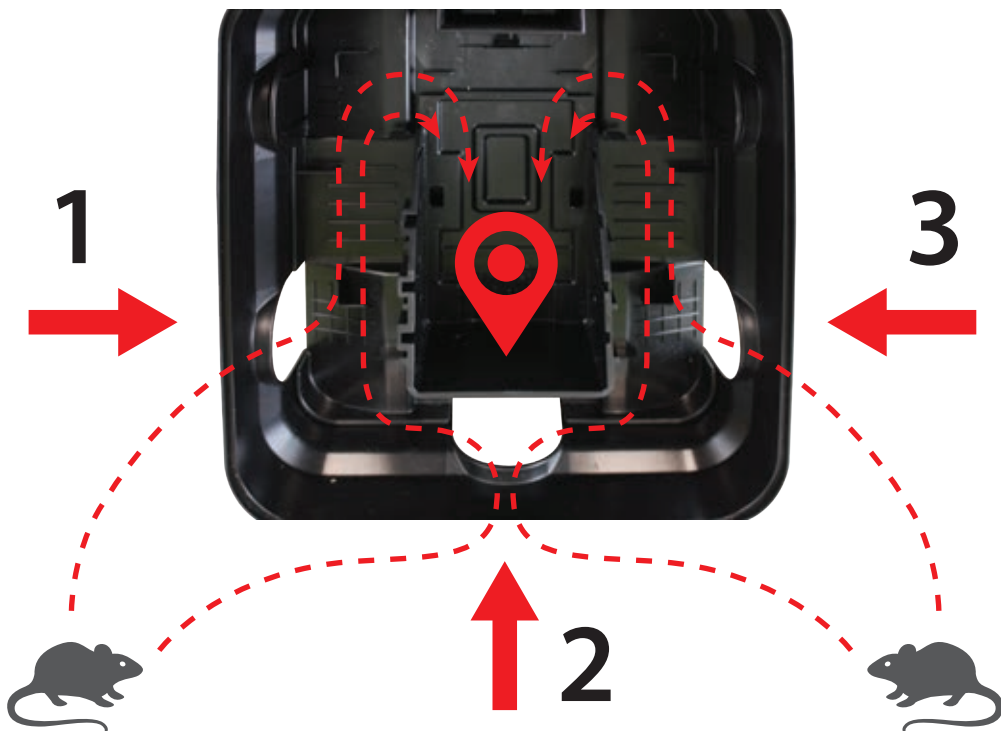

**PATENT PENDING**

# MULTIFUNCTIONAL RODENT BAIT STATION

Ideal for **HORIZONTAL** positioning on the floor.

**2** access entrances for rodents.



Ideal for **VERTICAL** positioning against the wall.

**3** access entrances for rodents.



**U LISSE**

Wall installation video

## **PATENT PENDING**

## **INNOVATIVE**

- **5 entrance holes for rodents**
- **Specially designed tray to facilitate the vertical climbing of rodents**
- **Safety tray for rodenticide bait and snap traps**

## **MULTIFUNCTIONAL**

- **Rodenticide bait dispenser**
- **Snap trap station**
- **Glue trap station**

## **VERSATILE**

- **Horizontal floor positioning (2 entrance holes)**
- **Vertical wall positioning (3 entrance holes)**



**U LISSE EC**



**RODENT**

**MULTIFUNCTIONAL  
VERSATILE  
CUSTOMISABLE  
PATENT PENDING**





# RODENT CONTROL

## CATCH TRAPS

### MECHANICAL

#### **P** LAIN-TRAP EC

##### **A** PLASTIC MULTIPLE CATCH TRAP EASY CHECK

Plastic multiple catch trap that can be used anywhere indoors and especially in humid places or where water is used. Its clear lid (easy check) makes it quicker for technicians to check for captured pests. This trap is recommended for monitoring programmes in food processing companies and in any case for the capture of house mice (*Mus domesticus*) and small rodents in general. There are slits on the lower part of the trap in order to catch crawling insects, making it useful for cockroach monitoring.

Its design with a flat lid and height of only 60 mm allows the operator to place the trap under pallets.

#### TECHNICAL DATA

Material: Polypropylene  
Colour: Black + transparent  
Dimensions: 270 x 185 x h 50 mm

Code:	Pack:	Pallet:
1455	21 pcs / pack	588 pcs / pallet



#### **D** UNE-TRAP EC

##### **B** PLASTIC MULTIPLE CATCH TRAP EASY CHECK

Plastic multiple catch trap that can be used anywhere indoors and especially in humid places or where water is used. Its clear lid (easy check) makes it quicker for technicians to check for captured pests. This trap is recommended for monitoring programmes in food processing companies and in any case for the capture of house mice (*Mus domesticus*) and small rodents in general. There are slits on the lower part of the trap in order to catch crawling insects, making it useful for cockroach monitoring.

The cover has been specially designed with 2 protrusions to hold 2 snap traps mod 9010 or 9013 (not included).

#### TECHNICAL DATA

Material: Polypropylene  
Colour: Black + transparent  
Dimensions: 270 x 185 x h 70 mm



Code:	Pack:	Pallet:
1555	18 pcs / pack	504 pcs / pallet





Mod. 1455

**P**LAIN-TRAP **EC**



Mod. 9499





**Mod. 1455**

**PLAIN-TRAP EC**



**Mod. 9500W**





Mod. 1555

**D**UNE-TRAP **EC**



Mod. 9013

**T**HOR-S





Mod. 1555

**DUNE-TRAP EC**

Mod. 9010



# RODENT CONTROL

## CATCH TRAPS

### MECHANICAL



#### **A** EASY CHECK RAT CATCH TRAP

Sturdy and tamper resistant bait station, made up of transparent HD polypropylene, suitable for indoor use.

Thanks to its special shape and to the hinged lid on the short side, it can be positioned anywhere, offering a low visual impact. It can also be easily inspected by operators.

Its main features:

- special dedicated locking key
- large entrance holes
- holds the rat snap trap model 9012 also available with remote control

It can be customised with pad printing or embossed logo directly on the plastic

The two items can also be used separately, respectively as rodenticide bait station and as rat snap trap.

#### TECHNICAL DATA

##### BAIT STATION

Material: HD Polypropylene  
Colour: Transparent  
Dimensions: 250 x 165 x h 105 mm  
Weight: 364 g

##### SNAP TRAP MOD. 9012

Material: ABS Plastic  
Colour: Black + red  
Dimensions: 142 x 77 x h 74 mm  
Weight: 118 g

Code:	Pack:	Pallet:
9052	12 pcs / pack	200 pcs / carton



Mod. 9315

**B**OXER EC



Mod. 9012

**T**HOR-XL

# RODENT CONTROL

## CATCH TRAPS INSTALLATION TIPS

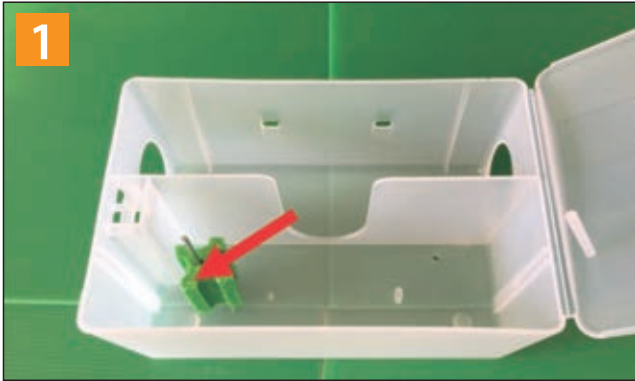

Place the non-toxic monitoring bait in the vertical rod (picture 1); then position the snap trap facing the bait (picture 2).



Once the trap is in place, press the back area until it is blocked (pictures 3 and 4).



The trap is now armed (picture 5) and the station can be closed.

If the trap is properly armed and active, the red trigger can be clearly seen through the transparent lid (picture 6).

If it is not visible, then it is necessary to check the eventual catch and re-arm the trap.



**WARNING: DO NOT ARM THE TRAP OUTSIDE THE BAIT STATION**

# RODENT CONTROL

## CATCH TRAPS

### MECHANICAL



#### **T** HOR-XL

##### **A** SHARK SHAPE SNAP TRAP FOR RODENTS

These two versions of sturdy and modern snap trap are designed to provide an ultra-fast action and a quick death thus avoiding rodent suffering, thanks to the strong interlocking teeth. Both models have a special bait-lodging cup and a red trigger to facilitate inspection.

Model 9012 is meant for rats, also big size ones. It can be safely and easily set by hand or by foot with no risk for the operator. It can also be used inside bait stations such as our models 9310 or 9315 to increase safety even further.

#### TECHNICAL DATA

Material: ABS plastic  
Colour: Black + red  
Dimensions: 142 x 77 x h 74 mm  
Weight: 118 g

Code:	Pack:	Carton:
9012	24 pc / pack	---



#### **T** HOR-S

##### **B** SHARK SHAPE SNAP TRAP FOR SMALL RODENTS

The new model 9013 has been specifically developed for mice control, and can catch even the smallest ones.

It can be easily set from behind to protect the operator's fingers.

#### TECHNICAL DATA

Material: ABS plastic  
Colour: Black + red  
Dimensions: 105 x 50 x h 57 mm  
Weight: 38 g

Code:	Pack:	Carton:
9013	48 pc / pack	---





# RODENT CONTROL

## CATCH TRAPS

### INSTALLATION TIPS



Be sure that the trap is UNARMED (picture 1); then turn counter-clockwise the bait cup slot (picture 2).



Withdraw the cup (picture 3) and fill it with the specific attractant (picture 4).



Re-insert the cup (picture 5) and turn it clockwise (picture 5). At this point, the trap can be safely armed (picture 6).



**WARNING: ALL THESE OPERATIONS MUST BE CONDUCTED WITHOUT HAVING THE TRAP SET**

# RODENT CONTROL

## CATCH TRAPS

### MECHANICAL



#### A SNAP TRAP FOR MICE

A durable modern trap designed to provide a fast and clean action. It can catch even the smallest mouse. It has a special bait-lodging cup. The trap can be easily set from behind to protect the operator's fingers.

##### TECHNICAL DATA

Material: Plastic  
Colour: Black  
Dimensions: 98 x 55 x h 50 mm  
Weight: 38 g

Code:	Pack:	Carton:
9010	40 pc / pack	---



#### B SNAP TRAP FOR RATS

This durable modern trap is designed to provide a fast and clean action. It can catch also big size rats. It has a special bait-lodging cup. The trap can be easily set from behind to protect the operators' fingers. It can also be used inside bait stations such as our models 9310 or 9315 to increase safety even further.

##### TECHNICAL DATA

Material: Plastic  
Colour: Black  
Dimensions: 140 x 80 x h 70 mm  
Weight: 94 g

Code:	Pack:	Carton:
9011	12 pc / pack	---



#### C REMOVABLE TRAPPING MECHANISM

Special removable trapping mechanism in galvanised steel, specifically designed to fit inside the new multifunctional traps model 9830 and 9835. Thanks to its special handle, it can be easily removed for a fast and efficient cleaning of the trap.

##### TECHNICAL DATA

Material: Galvanised steel sheet  
Dimensions: 50x 105 x h 40 mm  
Weight: 110 g

Code:	Pack:	Carton:
9499	8 pcs / pack	---

# RODENT CONTROL

## CATCH TRAPS

### MECHANICAL

#### **M**ULTI-CAT

##### **A** MULTIPLE CATCH TRAP SOLID

This version of automatic multiple catch trap has no inspection window. It captures up to 30 mice at a time. Suitable for small rodents. Entirely made of excellent quality galvanised steel, the trap is useful for rodent monitoring operations based on the HACCP methodology. A cardboard glue trap with attractant (mod. 9500) can be placed inside to make it easier to remove the captured mice. The glue trap also helps capture crawling insects coming in through the slits on the lower part of the trap.

###### TECHNICAL DATA

Material: Galvanised steel sheet  
Dimensions: 260 x 155 x h 50 mm



Code:	Pack:	Pallet:
9420	12 pcs / pack	720 pcs / plt

#### **M**ULTI-CAT EC

##### **B** MULTIPLE CATCH TRAP EASY CHECK

Multiple catch trap entirely made of galvanised steel sheet. It captures up to 30 mice. Particularly suitable for rodent control in a HACCP-based system. Inspection window to facilitate monitoring operations. Does not require bait.

###### TECHNICAL DATA

Material: Galvanised steel sheet  
Dimensions: 260 x 155 x h 50 mm



Code:	Pack:	Pallet:
9421	12 pcs / pack	720 pcs / plt

#### **B**ABY-CAT EC

##### **C** MULTIPLE CATCH TRAP EASY CHECK SMALL

Multiple catch trap for small rodents with practical top window for fast inspection. The two trapping mechanisms can be easily removed for quick cleaning of the trap and then simply re-positioned. This trap has reduced sizes, thus allowing its placement in particularly narrow and hard-to-reach positions.

###### TECHNICAL DATA

Material: Galvanised steel sheet  
Dimensions: 260 x 90 x h 45 mm

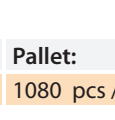

Code:	Pack:	Pallet:
9422	12 pcs / pack	1080 pcs / plt

# RODENT CONTROL

## CATCH TRAPS

### GLUE TRAPS



#### **A** CARDBOARD GLUE TRAP WITH FOOD ATTRACTANT

Cardboard glue trap containing food attractant, used to monitor and catch rodents or crawling insects in HACCP-regulated environments. It can either be used with mod. 9420 and 9421 multiple catch traps or individually.

Indicated for the quick removal of captured rats or insects. Absolutely non-toxic. Personalisation with your logo for minimum 10,000 pcs.

##### TECHNICAL DATA

Dimensions: 255 x 100 mm  
Scent: Hazelnut  
Lure: Food attractant

Code:	Pack:	Carton:
9500W	100 pcs / pack	---

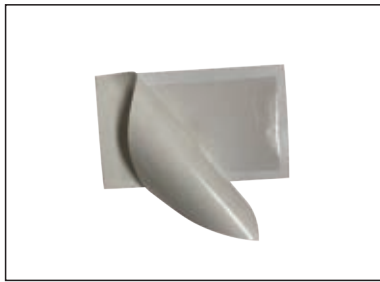

#### **B** CARDBOARD GLUE TRAP WITH FOOD ATTRACTANT

Cardboard glue trap used to monitor and catch rodents or crawling insects. Can be used together with PROTECTA PEST MONITOR, mod. 9850 and 9855 bait stations. Absolutely non-toxic. Personalisation with your logo for minimum 10,000 pcs.

##### TECHNICAL DATA

Dimensions: 155 x 95 mm  
Scent: Hazelnut  
Lure: Food attractant

Code:	Pack:	Carton:
9520W	160 pcs / pack	---



#### **C** PLASTIC GLUE TRAP WITH FOOD ATTRACTANT

Plastic glue trap with scent lure, used to monitor and catch rodents and crawling insects, for effective rodent control in HACCP-regulated situations. Thanks to the plastic base, it is ideal for use in humid environments, where the standard cardboard glue traps would quickly deteriorate.

It contains a non-toxic food attractant with bubblegum scent, that makes the trap extremely attractive.

##### TECHNICAL DATA

Base material: Plastic  
Dimensions: 255 x 100 mm  
Scent: Hazelnut  
Attractant: Food grade

Code:	Pack:	Carton:
9505	100 pcs / pack	---



#### **D** PLASTIC GLUE TRAP WITH FOOD ATTRACTANT

Plastic glue trap with scent lure, used to monitor and catch rodents and crawling insects, for effective rodent control in HACCP-regulated situations. Thanks to the plastic base, it is ideal for use in humid environments, where the standard cardboard glue traps would quickly deteriorate.

It contains a non-toxic food attractant with bubblegum scent, that makes the trap extremely attractive.

##### TECHNICAL DATA

Base material: Plastic  
Dimensions: 155 x 95 mm  
Scent: Hazelnut  
Attractant: Food grade

Code:	Pack:	Carton:
9525	160 pcs / pack	---

# RODENT CONTROL

## CATCH TRAPS

### GLUE TRAPS

#### A MAXI GLUE TRAY IN BLACK PLASTIC

Glue tray made of plastic used to monitor and catch rodents. Sold in practical, two-piece packs, this glue board is for indoor use and ensures excellent results also with medium-sized rodents. It can either be used separately or with mod. 9300 and 9305 bait stations or with tunnel mod. 9580, as an alternative to rodent bait.

##### TECHNICAL DATA

Dimensions: 250 x 120 x h 12 mm  
Colour: Black

Code:	Pack:	Carton:
9570	25 pairs / pack	---



#### B MAXI GLUE TRAY IN WHITE PLASTIC

Glue tray made of plastic used to monitor and catch rodents. Sold in practical, two-piece packs, this glue board is for indoor use and ensures excellent results also with medium-sized rodents. It can either be used separately or with mod. 9300 and 9305 bait stations or with tunnel mod. 9580, as an alternative to rodent bait.

##### TECHNICAL DATA

Dimensions: 250 x 120 x h 12 mm  
Colour: White

Code:	Pack:	Carton:
9575	25 pairs / pack	---



# RODENT CONTROL

## CATCH TRAPS

### GLUE TRAPS

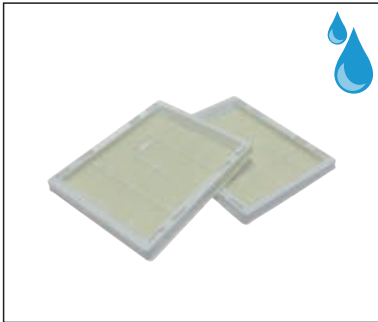

#### **A** MIDI GLUE TRAY IN WHITE PLASTIC

Sold in practical two-piece pack, this disposable glue tray is made of thermoformed plastic. It can either be used separately or inside mod. 9850A - 9855A - 9855B bait stations, both to catch and monitor medium-sized rodents in places where the use of poison is prohibited.

##### TECHNICAL DATA

Dimensions: 150 x 125 x h 9 mm  
Colour: White

Code:	Pack:	Carton:
9577	25 pairs / pack	---

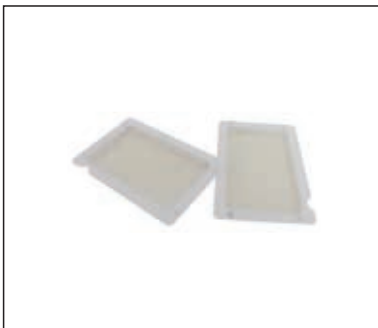

#### **B** MINI GLUE TRAY IN WHITE PLASTIC

Sold in practical two-piece pack, this disposable glue tray is made of thermoformed plastic. It can either be used separately or inside mod. 9850A - 9855A - 9855B bait stations, both to catch and monitor small sized rodents in places where the use of poison is prohibited.

##### TECHNICAL DATA

Dimensions: 140 x 90 x h 8 mm  
Colour: White

Code:	Pack:	Carton:
9576	25 pairs / pack	---



#### **C** GLUE TRAP ON MASONITE BASE

Glue trap on masonite base used to monitor and catch rodents or crawling insects. Sold in practical, two-piece packages, this glue board is for indoor use and ensures excellent results also with medium/large rodents thanks to the good quality of the glue and the board's weight. Also suitable for use in humid environments.

##### TECHNICAL DATA

Material: Masonite  
Dimensions: 280 x 190 mm

Code:	Pack:	Carton:
9550	24 pairs / pack	---

# RODENT CONTROL

## CATCH TRAPS

### GLUE TRAPS

#### A SMALL GLUE TRAP ON MASONITE BASE

Glue trap on masonite base used to monitor and catch rodents or crawling insects. Sold in practical, two-piece packages, this glue board is for indoor use and ensures excellent results thanks to the good quality of the glue and the board's weight. Also suitable for use in humid environments.

##### TECHNICAL DATA

Material: Masonite  
Dimensions: 155 x 190 mm

Code:	Pack:	Carton:
9555	24 pairs / pack	---

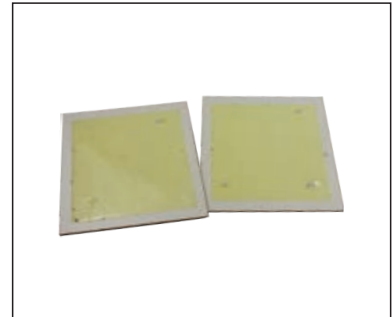

#### B MOLDABLE ADHESIVE CARDBOARD

New large-sized adhesive cardboard for catching even large rodents. The special structure with pre-printed rectangular sections allows the cardboard to be folded and assembled in different ways, adapting it to every circumstance and allowing the operator to optimise space according to actual needs. The particularly abundant weight of glue guarantees the capture and retention of the rodent.

##### TECHNICAL DATA

Material: Carton  
Dimensions: 330 x 210 mm

Code:	Pack:	Carton:
9560	10 pcs / pack	---



 **RODENT**<sup>®</sup>  
is an OSD group brand



[osdgroup.eu](http://osdgroup.eu)

# RODENT CONTROL

## CATCH TRAPS

### CAGES



#### **A** MULTICATCH CAGE TRAP FOR SMALL RODENTS

Specific painted steel wire cage for catching small rodents. Equipped with two entrances with catching mechanisms, it allows the multi-capture of rodents. Easily managed and inspected, it is an indispensable item for accurate control of the mouse population without the use of poison. Pre-assembled and ready to use.

##### TECHNICAL DATA

Material: Galvanised steel  
Color: Brown  
Cage dimensions: 300 x 120 x h 110 mm  
Weight: 300 g

Code:	Pack:	Pallet:
9060	1 pc / pack	---



#### **B** MULTICATCH CAGE TRAP FOR MEDIUM-LARGE RODENTS

Specific painted steel wire cage for catching rodents, including medium and large-sized ones. Equipped with two entrances with catching mechanisms, it allows the multi-capture of rodents. Easily managed and inspected, it is an indispensable item for accurate control of the mouse population without the use of poison. Pre-assembled and ready to use.

##### TECHNICAL DATA

Material: Galvanised steel  
Color: Brown  
Cage dimensions: 480 x 250 x h 180 mm  
Weight: 880 g

Code:	Pack:	Pallet:
9048	1 pc / pack	---



#### **C** CAGE TRAP FOR RATS

A practical galvanised steel cage trap for catching medium-sized animals (rats, cats, nutriae, rabbits, etc.), that can be used both inside and outside premises where the presence of one or more rats is known. Harmless to the trapped animal and easy to install with only a few simple moves, it has a practical rear door which makes it possible to reach the prey immediately.

##### TECHNICAL DATA

Material: Galvanised steel  
Cage dimensions: 443 x 200 x h 190 mm  
Weight: 1550 g

Code:	Pack:	Pallet:
TZ3482	1 pc / pack	---

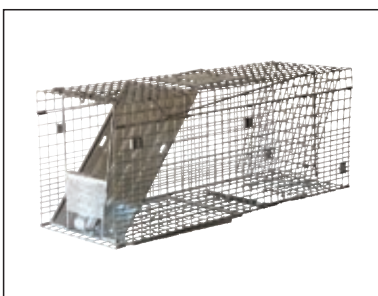

#### **D** CAGE TRAP FOR SMALL SIZED ANIMALS

Practical steel cage for catching small animals (small rats, squirrels, dormice, etc.). Ready to use, harmless to captured animals and easy to install, it gives excellent results in a very short time. Simply add food bait that will attract the prey inside the cage trap.

##### TECHNICAL DATA

Material: Galvanised steel  
Cage dimensions: 813 x 318 x h 267 mm  
Weight: 4700 g

Code:	Pack:	Pallet:
TZ3304	1 pc / pack	---



# RODENT CONTROL

## CATCH TRAPS

### CAGES

#### A CAGE TRAP FOR SMALL SIZED ANIMALS

Practical steel cage for catching small animals (small rats, squirrels, dormice, etc.). Thanks to its special shape, it can be easily installed in a few simple steps. Harmless to captured animals, it gives excellent results in a very short time. Simply add food bait that will attract the prey inside the cage trap.

##### TECHNICAL DATA

Material: Galvanised steel  
Cage dimensions: 1020 x 250 x h 250 mm  
Weight: 4000 g

Code:	Pack:	Pallet:
TZ3325	1 pc / pack	---



#### B ONE-DOOR CAGE TRAP FOR NUTRIAE (*Myocastor coypus*)

This trap has one entrance door that closes automatically when the nutria enters the cage and walks on the platform, attracted by the bait positioned right beyond it. The door will close down and catch the animal inside the cage. This trap is pre-assembled and ready for use.

##### TECHNICAL DATA

Material: Galvanised steel  
Wire diameter: 2.2 mm  
Mesh dimensions: 24 x 24 mm  
Cage dimensions: 825 x 320 x h 340 mm

Code:	Pack:	Pallet:
TZ3355	1 pc / pack	---



#### C TWO-DOOR CAGE TRAP FOR NUTRIAE (*Myocastor coypus*)

This trap has two entrance doors that close automatically when the nutria enters the cage and walks on the platform, attracted by the bait positioned right beyond it, at the centre of the cage. The doors will immediately close down and catch the animal inside the cage. This trap is pre-assembled and ready for use.

##### TECHNICAL DATA

Material: Galvanised steel  
Wire diameter: 2.2 mm  
Mesh dimensions: 24 x 24 mm  
Cage dimensions: 1010 x 320 x h 340 mm

Code:	Pack:	Pallet:
TZ3370	1 pc / pack	---



# RODENT CONTROL

## ACCESSORIES

### FIXING SYSTEMS

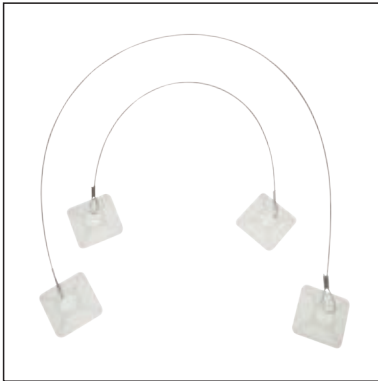

#### **A** FIXING SYSTEM FOR STATIONS AND TRAPS

Versatile fixing system for any kind of rodent bait stations and traps.

The kit includes 2 fixing plates with top quality 3M adhesive connected to each other by means of a polyethylene-coated stainless steel wire, with a varying length (25-50 cm), according to the model. One plate has to be fixed to the station and the other one to the wall.

The trap will remain perfectly in place, though it can easily be removed for floor cleaning.

##### TECHNICAL DATA MOD. 9725

###### PLATES

Material: Polypropylene  
Dimensions: 27 x 27 x h 6 mm

###### WIRE

Material: Aise 316 stainless steel  
Length: 250 mm  
Diameter: 0.7 mm

##### TECHNICAL DATA MOD. 9750

###### PLATES

Material: Polypropylene  
Dimensions: 27 x 27 x h 6 mm

###### WIRE

Material: Aise 316 stainless steel  
Length: 500 mm  
Diameter: 0.7 mm

Code:	Pack:	Carton:
9725	12 pcs / pack	---
9750	12 pcs / pack	---

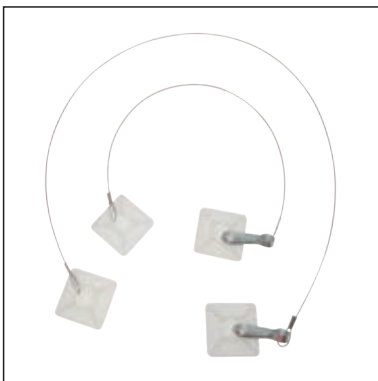

#### **B** FIXING SYSTEM FOR STATIONS AND TRAPS

Versatile fixing system for any kind of rodent bait stations and traps.

The kit includes 2 fixing plates with top quality 3M adhesive connected to each other by means of a polyethylene-coated stainless steel wire and a special hook to easily fasten and unfasten the station/trap.

The length of the wire varies (25-50 cm), according to the model.

One plate has to be fixed to the station and the other one to the wall.

The trap will remain perfectly in place, though it can easily be removed for floor cleaning.

This version with the hook gives the opportunity to quickly release the station yet leaving the fixing system in place.

##### TECHNICAL DATA MOD. 9725G

###### PLATES

Material: Polypropylene  
Dimensions: 27 x 27 x h 6 mm

###### WIRE

Material: Aise 316 stainless steel  
Length: 250 mm  
Diameter: 0.7 mm

##### TECHNICAL DATA MOD. 9750G

###### PLATES

Material: Polypropylene  
Dimensions: 27 x 27 x h 6 mm

###### WIRE

Material: Aise 316 stainless steel  
Length: 500 mm  
Diameter: 0.7 mm

Code:	Pack:	Carton:
9725G	12 pcs / pack	---
9750G	12 pcs / pack	---

# RODENT CONTROL

## ACCESSORIES

### FIXING SYSTEMS

#### A SPECIAL ALLEN KEY FOR TRAPEZOID SHAPED STATIONS

Specific non-commercial Allen key for opening Ecorodent mod 9300, 9301, 9302, 9305, 9306, 9307, 9480. Its special shape makes it indispensable for opening safety bait stations, as standard Allen keys do not allow this.

##### TECHNICAL DATA

Material: Galvanised steel

Code:	Pack:	Pallet:
9640	12 pcs / pack	---



#### B SPECIAL MULTI KEY FOR ECORODENT STATIONS

Specific key in red plastic for opening many bait stations of the Ecorodent range

##### TECHNICAL DATA

Material: Plastic  
Color: Red

Code:	Pack:	Pallet:
9645	1 pc / pack	---



#### C RODENTICIDE BAIT ROD FOR BAIT STATIONS

Specific "L" shaped rods for safe anchoring of the rodenticide bait. Ideal for the safety tray contained in the FORTEZZA and TRAPEZIO models.

##### TECHNICAL DATA

Material: Galvanised steel  
Lenght: 180 mm

Code:	Pack:	Pallet:
9630	12 pcs / pack	---

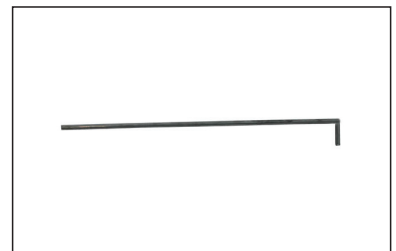

#### D RODENTICIDE BAIT ROD FOR T-SHAPED STATIONS

Specific "L" shaped rods for secure anchoring of rodenticide bait. Ideal for "T" series models 9310T, 9315T, 2250T, 2255T

##### TECHNICAL DATA

Material: Galvanised steel  
Lenght: 220 mm

Code:	Pack:	Pallet:
AST-12T	12 pcs / pack	---

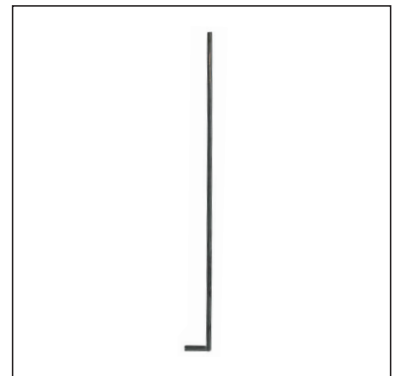

# RODENT CONTROL

## ACCESSORIES

### FIXING SYSTEMS

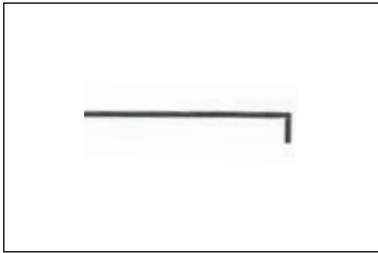

#### **A** RODENTICIDE BAIT RODS FOR CRYSTAL STATIONS

Specific 'L'-shaped rods for safe anchoring of rodenticide bait. Ideal for the safety tray contained in CRYSTAL models.

##### TECHNICAL DATA

Material: Galvanised steel  
Lenght: 110 mm

Code:	Pack:	Pallet:
AST110	20 pcs / pack	---



#### **B** RODENTICIDE BAIT RODS FOR ULISSE/CRYSTAL STATIONS

Specific 'L'-shaped rods for safe anchoring of rodenticide bait. Ideal for the safety tray contained in ULISSE and CRYSTAL models.

##### TECHNICAL DATA

Material: Galvanised steel  
Lenght: 90 mm

Code:	Pack:	Pallet:
9390FA	24 pcs / pack	---



#### **C** RODENTICIDE BAIT RODS FOR BIBOX/BIBOX EVO STATIONS

Specific rods for safe anchoring of rodenticide bait. Ideal for BIBOX and BIBOX EVO models.

##### TECHNICAL DATA

Material: Galvanised steel

Code:	Pack:	Pallet:
9850FA	24 pcs / pack	---

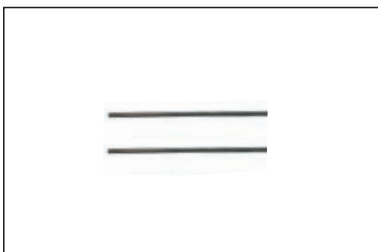

#### **D** RODENTICIDE BAIT RODS FOR PLAINTRAP/DUNE-TRAP STATIONS

Specific rods for safe anchoring of rodenticide bait. Ideal for PLAIN-TRAP and DUNE-TRAP models.

##### TECHNICAL DATA

Material: Galvanised steel

Code:	Pack:	Pallet:
1555FA	36 pcs / pack	---

# RODENT CONTROL

## ACCESSORIES FIXING SYSTEMS

### A LONG RODENTICIDE BAIT RODS FOR BOXER STATIONS

Specific rods for safe anchoring of rodenticide bait. Ideal for BOXER models.

#### TECHNICAL DATA

Material: Galvanised steel

Code:	Pack:	Pallet:
AST228	24 pcs / pack	---



### B SHORT RODENTICIDE BAIT RODS FOR BOXER STATIONS

Specific rods for safe anchoring of rodenticide bait. Ideal for BOXER models.

#### TECHNICAL DATA

Material: Galvanised steel

Code:	Pack:	Pallet:
AST90	48 pcs / pack	---

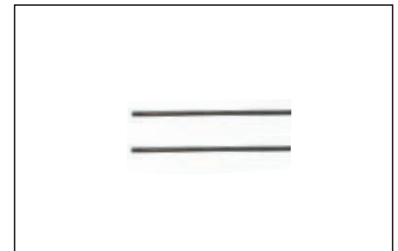

### C FASTENING KIT FOR TRAPEZOID-SHAPED BAIT STATIONS

Practical kit supplied with trapezoid-shaped plastic bait station of the series 9300, offering versatile fastening solutions for any situation. The kit includes wall and pole fastening accessories, pins to secure bait, and station identification label to affix directly to the bait station.

#### TECHNICAL DATA

One kit includes: 1 rodent bait pins, 1 U-shaped hook for pole fixing, 1 station identification label, 1 wall plug, 1 screw, 2 washers, 2 wing nuts

Code:	Pack:	Carton:
9650	12 pcs / pack	---



### D FASTENING KIT FOR ULISSE STATIONS

Specific KIT for anchoring the ULISSE bait stations mod 9390 and 9395.

#### TECHNICAL DATA

The kit contains 1 wall fastening accessory, 3 bait rods, 2 plugs, 2 screws, 1 station identification label.

Code:	Pack:	Pallet:
KIT9390	12 pcs / pack	---



# RODENT CONTROL

## ACCESSORIES

### FIXING SYSTEMS



#### **A** FASTENING KIT FOR CRYSTAL BAIT STATIONS

Specific KIT for anchoring the CRYSTAL bait stations ideal for floor horizontal positioning (mod 9410 and 9415).

##### TECHNICAL DATA

The kit contains 1 wall fastening accessory and 1 bait rod (mod AST110).

Code:	Pack:	Carton:
KIT9410	20 pcs / pack	---



#### **B** FASTENING KIT FOR CRYSTAL BAIT STATIONS

Specific KIT for anchoring the CRYSTAL bait stations ideal for wall vertical positioning (mod 9412).

##### TECHNICAL DATA

The kit contains 1 wall fastening accessory and 2 bait rods (mod 9390FA).

Code:	Pack:	Carton:
KIT9412	20 pcs / pack	---



#### **C** FASTENING KIT FOR T-SHAPED STATIONS

Specific KIT for anchoring "T" series models 9310T, 9315T, 2250T, 2255T.

##### TECHNICAL DATA

The kit contains 1 bait rod, 2 plugs, 2 screws and 1 station identification label.

Code:	Pack:	Pallet:
KIT-12T	12 pcs / pack	---

# RODENT CONTROL

## ACCESSORIES

### FIXING SYSTEMS

#### **A** FASTENING KIT FOR BOXER BAIT STATIONS

Specific KIT for anchoring the BOXER bait stations mod 9310 and 9315.

##### TECHNICAL DATA

One kit includes: 1 wall fastening accessory, 2 nuts, 2 screws, 1 long bait rod (mod AST228) and 2 short bait rods (mod AST90).

Code:	Pack:	Carton:
9310ACC	24 pcs / pack	---

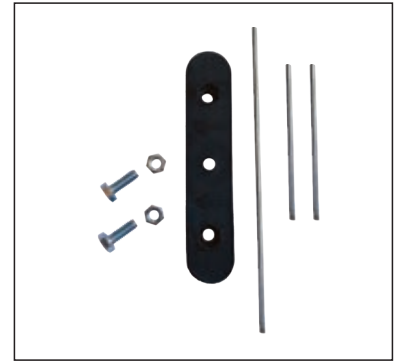

#### **B** FASTENING KIT FOR BIBOX BAIT STATIONS

Specific KIT for anchoring the BIBOX bait stations mod 9850A and 9855A.

##### TECHNICAL DATA

The kit contains 1 wall fastening accessory and 1 bait rod.

Code:	Pack:	Carton:
KIT9850	24 pcs / pack	---

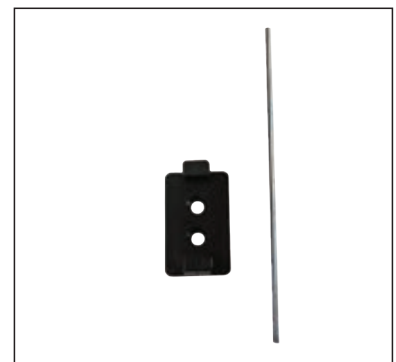

#### **C** FASTENING KIT FOR BIBOX EVO BAIT STATIONS

Specific KIT for anchoring the BIBOX EVO bait stations mod 9820A and 9825A.

##### TECHNICAL DATA

The kit contains 1 wall fastening accessory and 1 bait rod.

Code:	Pack:	Carton:
KIT9820	20 pcs / pack	---



# RODENT CONTROL

## ACCESSORIES

### SPARES



#### **A** RODENTICIDE BAIT TRAY FOR TRAPEZIO STATIONS

This versatile and practical inner tray has been designed so that operators can safely use all types of rodent bait (blocks, pellets, pasta, etc.). Its special shape is designed to prevent accidental contact with the rodent bait, ensuring maximum safety.

Ideal for stations Mod. 9300, 9301, 9302, 9305, 9306, 9307, 9480.

#### TECHNICAL DATA

Material: Polystyrene  
Colour: Black



Code:	Pack:	Carton:
9620	40 pcs / pack	---





# RODENT CONTROL

## ACCESSORIES

### SPARES

#### **A** MULTIFUNCTION BLACK TRAY FOR ULISSE STATIONS

Specific black multifunction tray for horizontal/vertical customisation of the ULISSE series rodenticide bait stations. By rotating the tray, it is possible to obtain 2 or 3 rodent entry holes in the station and determine its location, either vertically on the wall or horizontally on the floor. The tray is designed to accommodate either a safety tray or a glue trap. Ideal for mod 9390 and 9395.

##### TECHNICAL DATA

Material: HD polypropylene  
Colour: Black

Code:	Pack:	Carton:
9390VAS	12 pcs / pack	---



#### **B** MULTIFUNCTION CLEAR TRAY FOR ULISSE STATIONS

Specific transparent multifunction tray for horizontal/vertical customisation of the ULISSE series rodenticide bait stations. By rotating the tray, it is possible to obtain 2 or 3 rodent entry holes in the station and determine its location, either vertically on the wall or horizontally on the floor. The tray is designed to accommodate either a safety tray or a glue trap. Ideal for mod 9390 and 9395.

##### TECHNICAL DATA

Material: HD polypropylene  
Colour: Transparent

Code:	Pack:	Carton:
9390VASTR	12 pcs / pack	---

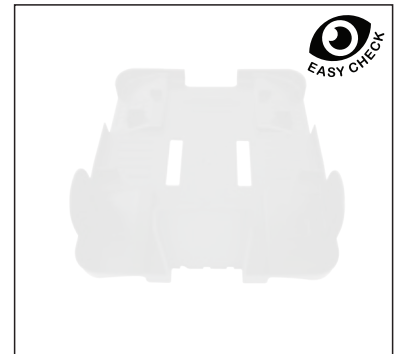

# RODENT CONTROL

## ACCESSORIES

### SPARES

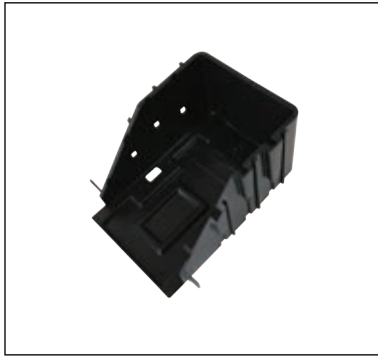

#### **A** RODENTICIDE BAIT TRAY FOR ULISSE/CRYSTAL STATIONS

Specific rodenticide bait tray for ULISSE (models 9390 and 9395) and CRYSTAL (model 9412).

##### TECHNICAL DATA

Material: HD polypropylene  
Colour: Black

Code:	Pack:	Carton:
9399	12 pcs / pack	---



#### **B** RODENTICIDE BAIT TRAY FOR CRYSTAL STATIONS

Specific thermoformed tray for CRYSTAL bait stations (models 9410 and 9415).

##### TECHNICAL DATA

Material: Polystyrene  
Colour: Black

Code:	Pack:	Carton:
9623	40 pcs / pack	---



# RODENT CONTROL

## ACCESSORIES

### SPARES

#### A IDENTIFICATION LABEL FOR T-SHAPED BAIT STATIONS

Bait station identification label supplied with bait station models 9810T and 2250T. It is useful for numbering the permanent bait stations, for quick identification and short notes, such as the frequency of checks that have been carried out.

The transparent version is supplied with bait station models 9815T and 2255T.

##### TECHNICAL DATA

Material: PVC

Code:	Pack:	Carton:
9663T	60 pcs / pack	---
9663TR	60 pcs / pack	---

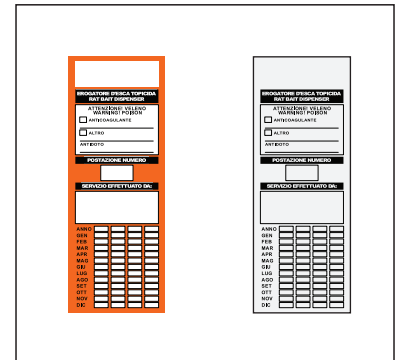

#### B IDENTIFICATION LABEL FOR ULISSE STATIONS

Bait station identification label for ULISSE models 9390 and 9395.

##### TECHNICAL DATA

Dimensions: 100 x 50 mm

Code:	Pack:	Carton:
9390ADE	12 pcs / pack	---



#### C INSPECTION STICKER

Inspection stickers used to note the frequency of checks that have been carried out - available upon request.

##### TECHNICAL DATA

Dimensions: 35 x 200 mm

Stickers per sheet: 7

Code:	Pack:	Carton:
9670	70 pcs / pack	---

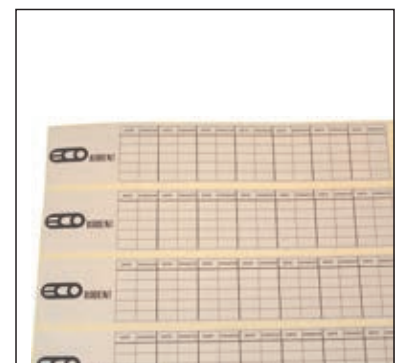

# COME OUT OF THE SHADOWS

Customise your station with your pad-printed logo



# RODENT CONTROL

## CUSTOMISATION

### PAD-PRINTING

NOTICE: Please contact our Export Sales Dept to check the cost for the realization of the padprint

#### **T RAPEZIO**

**9300P**



Pack:  
18 pcs / pack  
Minimum order:  
360 pcs

#### **T RAPEZIO EC**

**9305P**



Pack:  
18 pcs / pack  
Minimum order:  
360 pcs



#### **T RAPEZIO**

**9301P**



Pack:  
18 pcs / pack  
Minimum order:  
360 pcs

#### **T RAPEZIO EC**

**9306P**



Pack:  
18 pcs / pack  
Minimum order:  
360 pcs



#### **T RAPEZIO**

**9302P**



Pack:  
18 pcs / pack  
Minimum order:  
360 pcs

#### **T RAPEZIO EC**

**9307P**



Pack:  
18 pcs / pack  
Minimum order:  
360 pcs



#### **F ORTEZZA**

**9480P**



Pack:  
12 pcs / pack  
Minimum order:  
300 pcs

#### **G RYDAL**

**9412P**



Pack:  
20 pcs / pack  
Minimum order:  
440 pcs

#### **G RYDAL**

**9410P**



Pack:  
20 pcs / pack  
Minimum order:  
440 pcs

#### **G RYDAL EC**

**9415P**



Pack:  
20 pcs / pack  
Minimum order:  
440 pcs



# RODENT CONTROL

## CUSTOMISATION

### PAD-PRINTING

NOTICE: Please contact our Export Sales Dept to check the cost for the realization of the padprint

#### **B OXER**

**9310P**



Pack:

22 pcs / pack

Minimum order:

484 pcs

#### **B OXER EC**

**9315P**



Pack:

22 pcs / pack

Minimum order:

484 pcs



#### **B IBOX EVO**

**9820AP**



Pack:

20 pcs / pack

Minimum order:

400 pcs

#### **B IBOX EVO EC**

**9825AP**



Pack:

20 pcs / pack

Minimum order:

400 pcs



#### **B IBOX**

**9850AP**



Pack:

30 pcs / pack

Minimum order:

720 pcs

#### **B IBOX EC**

**9855AP**



Pack:

30 pcs / pack

Minimum order:

720 pcs



#### **T MAXI**

**9810TP**



Pack:

12 pcs / pack

Minimum order:

336 pcs

#### **T MAXI EC**

**9815TP**



Pack:

12 pcs / pack

Minimum order:

336 pcs



#### **T MINI**

**2250TP**



Pack:

24 pcs / pack

Minimum order:

768 pcs

#### **T MINI EC**

**2255TP**



Pack:

24 pcs / pack

Minimum order:

768 pcs



# RODENT CONTROL

## CUSTOMISATION

### PAD-PRINTING

NOTICE: Please contact our Export Sales Dept to check the cost for the realization of the padprint

#### **M**ULTI-CAT

9420P



Pack:

12 pcs / pack

Minimum order:

720 pcs

#### **M**ULTI-CAT **EC**

9421P



Pack:

12 pcs / pack

Minimum order:

720 pcs



#### **P**LAIN-TRAP **EC**

1455P

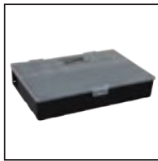

Pack:

21 pcs / pack

Minimum order:

420 pcs



#### **D**UNE-TRAP **EC**

1555P

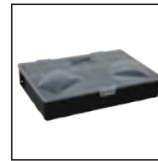

Pack:

18 pcs / pack

Minimum order:

504 pcs



#### **U**LISSE

9390P



Pack:

12 pcs / pack

Minimum order:

360 pcs

#### **U**LISSE **EC**

9395P



Pack:

12 pcs / pack

Minimum order:

360 pcs



#### **O**MNIBOX

9370P



Pack:

20 pcs / pack

Minimum order:

1680 pcs

#### **O**MNIBOX **EC**

9375P



Pack:

20 pcs / pack

Minimum order:

1680 pcs



#### **P**ETIT

9330P



Pack:

12 pcs / pack

Minimum order:

2400 pcs

9900P



Pack:

50 pcs / pack

Minimum order:

2600 pcs

# INSECT CONTROL

## TRAPS

4INSECTS RANGE	128
FLY CUT	131
FLIES	132
RED PALM WEEVILS	133
BROWN MARMORATED STINK BUGS	134
CRAWLING INSECTS	135

## BAIT STATIONS

CRAWLING INSECTS	137
------------------	-----

W  
E  
S  
T  
4







# 4INSECTS



## **A** GLUE TRAP FOR COCKROACHES

### WITH ATTRACTANT TABLETS

This glue trap is made of plastic coated cardboard that is easily folded to form a little "hut". The inside base is covered with an even layer of non-toxic glue; the new 4insects version comes with a food attractant tablet already positioned at the centre of the glued base.

Thanks to its compact size, FLY005 can be placed under working tables, refrigerators, ovens, washing basins and kitchens, to progressively and continuously catch Oriental cockroaches (*Blatta orientalis*), German cockroaches (*Blattella germanica*), etc. as well as to correctly monitor and control the presence of crawling insects.

### TECHNICAL DATA

Material: Plastic coated cardboard  
Lure: Food attractant tablet  
Dimensions: 210 x 100 x h 30 mm

Code:	Pack:	Carton:
HPRFLY005	10 pcs / pack	200 pcs / carton

# 4INSECTS



## A 4INSECTS MONITOR TRAP FOR FLYING INSECTS

The trap is easy to assemble and hang. Featuring a large surface covered with glue on all three inner sides, it is ideal for the monitoring and capture of Lepidoptera, wood boring insects, and many other flying insects. Pheromones are not included in the trap, and must be purchased apart.



Code:	Pack:	Carton:
HPR1103	10 pcs / pack	100 pcs / carton

## B 4INSECTS CHECK TRAP

This brand new diamond shaped glue trap is made of resistant cardboard, with winged edges to protect the glue from dust. It is the ideal solution for the catch of flying insects in food processing and storage areas. The pheromone lure is not included.



Code:	Pack:	Carton:
HPR1106	5 pcs / pack	75 pcs / carton



**CONTACT OUR EXPORT SALES DEPT TO HAVE INFO ON THE WIDE RANGE OF PHEROMONES**

# 4INSECTS



## A 4INSECTS HOLDER

Special holder in clear plastic for 4INSECTS glue pads. It comes flat, in practical 10-piece-packs. Easy-to-assemble, cost effective, reusable. A liquid lure can be added in the dedicated reservoir at the bottom of the holder, to further increase the catching activity of the glue pads. It can be easily hanged, thanks to the hook shape design.

### TECHNICAL DATA

Dimensions: h 235 x 65 x 40 mm (assembled)

Code:	Pack:	Carton:
HPR1104	10 pcs / pack	---

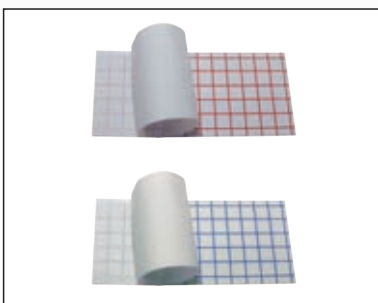

## B 4INSECTS PAD

Glue pads in plastic, pre-baited with specific pheromones. Mod HPR1109 has a grid printed in red and contains a pheromone for catching *Plodia interpunctella* and *Ephestia spp.* Mod HPR1101 has a blue grid and is ideal for clothes moths (*Tineola bisselliella*).

### TECHNICAL DATA

Color: Red (*Plodia/Ephestia*)  
Blue (*Tineola bisselliella*)  
Dimensions: 130 x 60 mm

Code:	Target:	Pack:	Carton:
HPR1109	<i>Plodia/Ephestia</i>	2 pcs / pack	---
HPR1101	<i>Tineola bisselliella</i>	2 pcs / pack	---

# FLY CUT

## IRRESISTIBLY ATTRACTIVE FLY TRAP



### A FLY CUT

Fly Cut is a trap designed to mass control a variety of fly species. Recommended for use in outdoor areas for the perimeter protection of livestock farms, pastures, parking lots, wide areas, etc. The bait supplied in the new dust formulation is an attractant mixture made from fermented yeasts. It is a patented, one-of-a-kind product that attracts flies 10 times more than standard fly traps on the market. The Fly Cut trap has six cones along the circumference so that flies can enter but cannot exit. The trap is amazingly effective and produces instant results.

Each kit includes: 1 bucket, 1 lid, 6 cones, 1 bottle with 240 gr of Fly Cut dust.



### B FLY CUT DUST ATTRACTANT

Spare bottle of dust attractant mixture made from fermented yeasts. It is a patented, one-of-a-kind product that attracts flies 10 times more than standard fly traps on the market.

Each bottle contains 240 gr of Fly Cut dust.



CONTACT OUR EXPORT SALES DEPT FOR DETAILED INFO

# INSECT CONTROL

## TRAPS

### FLIES



#### **A** GREEN TOP TRAP

New trap for the control of flies and Diptera, made up of a plastic bag and 50 gr of the innovative and highly attractive soluble dust. To activate the trap, simply remove the green cap, pour the dust into the bag and add 600/700 ml of water. Lured by the scent, flies will enter the trap through the top cap and drown in the water. It is intended for use outdoors, for the protection of industries, livestock farms and warehouses in general.

\* Each kit contains 6 complete traps, made up of 6 Green Top Traps and 6 bags of Dust (50 gr each).

Code:	Pack:	Carton:
HPRFLYTRAP	1 kit / pack *	---



#### **B** FLY GLUE PAPER IN ROLL

Large roll of sticky paper used to catch flying insects, recommended to control flies in structures such as cowsheds, milking parlours, pigsties, etc. The system is based on a combination of coatings and fluorescent colours that are particularly attractive for flies. Noflytrap is very effective in both dark and light places.

Each roll comes with a dedicated metallic hanger.

##### TECHNICAL DATA

Length: 9 mt  
Width: 30 cm

Code:	Pack:	Carton:
HPR9006	1 pc / pack	---



#### **C** FLY GLUE PAPER IN SMALL ROLL

Small paper roll ideal for the control of flies at home. Ready to use and disposable. Hang the trap in areas of high fly activity and simply unroll the glue paper. It remains effective for months.

##### TECHNICAL DATA

Material: paper with glue  
Length: 70 cm  
Width: 50 mm

Code:	Pack:	Carton:
HPR9008	12 pcs / pack	---



#### **D** FLY GLUE STRING

This 400 mt long glue coated plastic string is mounted on a robust reel and comes fully equipped for suspending in animal sheds, animal farms, horse stables, silos, etc. The reel is designed to be mounted at ceiling height. Flies land on the string and get caught in the sticky glue. It is extremely effective and can catch up to 500 flies per linear meter.

Once installed, it is an easy task to replace the spare reel (HPR9019) and continue catching flies all season long.

1 kit includes: 1 hanging bracket, 1 spare reel (400 mt), 1 empty reel, pulleys and fixing screws.

Code:	Pack:	Carton:
HPR9016	1 pc / pack	---
HPR9019	1 pc / pack	---

# INSECT CONTROL

## TRAPS

### RED PALM WEEVILS

#### A XLURE CHECK POINT RF

Check Point is a plastic trap that is ideal for the outdoor monitoring of *Rhynchophorus ferrugineus* (red palm weevil). Water must be introduced inside the transparent plastic bucket in order to detain the insect once it is caught.

Aggregation pheromone specifically for *Rhynchophorus ferrugineus* can be placed at the centre of the lid. While searching for an effective palm treatment method, monitoring this insect is a valid method to quickly spot the presence of an infestation in a determinate place and to evaluate if the corrective actions taken on the palm trees (cutting down the tree, chemical treatment) have been successful. In Asian regions, where this insect comes from, mass trapping strategies using these pheromones are taking place.

The trap must be covered by a net so that the red palm weevil can climb into the trap.

The pack includes:

- 1 bucket trap
- 1 pheromone
- 1 net

Code:	Pack:	Carton:
HPR1041	1 pc / pack	---



#### B PHEROMONE FOR RED PALM WEEVIL

Rhylure is an aggregation pheromone for the *Rhynchophorus ferrugineus* (red palm weevil).

It comes in small plastic slow-release bags. It is used throughout the world for the monitoring and mass trapping of these insects.

Rhylure is a pheromone dispenser that is used inside traps to quickly determine if palm trees are infested by red palm weevils and consequently take the necessary measures to limit the infestation and the development of this insect.

Code:	Pack:	Carton:
HPR2310	1 pc / pack	---



# INSECT CONTROL

## TRAPS

### BROWN MARMORATED STINK BUGS



#### **A** BROWN MARMORATED STINK BUG KIT

Dedicated trap for monitoring and catching *Halyomorpha halys* (brown marmorated stink bug). The container is in green plastic and has a grid on both sides; the kit is completed by a cardboard glue trap and a specific pheromone to be positioned inside.

\* Each kit includes 1 pheromone, 1 plastic container, 2 cardboard glue traps

#### TECHNICAL DATA

Trap dimensions: 280 x 195 x h 110 mm (assembled)

Code:	Pack:	Carton:
HPR1038	1 kit / pack *	---

### SPARE PARTS

#### HPR1034



**Description:**  
Specific container in green plastic with a grid on both sides.

Pack:  
1 pc



#### HPR1039



**Description:**  
Cardboard glue trap to be placed inside the green plastic container.

Pack:  
2 pcs



#### HPR1094



**Description:**  
This pheromone has been specifically developed to control *Halyomorpha halys*.

**Duration:** Approx. 6 weeks  
**Coverage:** 50 mq

Pack:  
1 pc





# INSECT CONTROL

## TRAPS

### CRAWLING INSECTS

#### A HALFMOON INSECT STATION

Plastic trap used to create permanent monitoring stations for crawling insects. Unique on the market, this trap has a special holder for pheromone or food attractant tablets. It can be used together with a cardboard glue trap (mod 9530) or as a bait station by placing a few drops of gel insecticide inside. By attaching it to rodent bait station model 9330 (black colour), it becomes a product that simultaneously monitors both rodents and crawling insects.

##### TECHNICAL DATA

Content: 12 traps + 12 glue boards  
Material: Polypropylene  
Colour: Transparent  
Dimensions: 85 x 140 x h 15 mm

Code:	Pack:	Pallet:
HPR9220	12 pcs / pack	2400 pcs / pallet



#### B GLUE BOARD

Glue board used to catch and monitor crawling insects. It can be used with the mod. 9220 trap and with any stations for catching silverfish (*Lepisma*) and barklouse (*Psocoptera*).

##### TECHNICAL DATA

Dimensions: 50 x 60 mm

Code:	Pack:	Carton:
HPR9530	20 pcs / pack	1600 pcs / carton



#### C ATTRACTANT TABLETS FOR COCKROACHES

Food attractant tablets for cockroaches, for use with glue traps. Packed in a plastic bottle containing 50 tablets.

##### TECHNICAL DATA

Lure: Food attractant

Code:	Pack:	Carton:
HPR1009	50 pcs / pack	---



# INSECT CONTROL

## TRAPS

### CRAWLING INSECTS



#### **A** ADHESIVE BARRIER TAPE

A multiple-use adhesive barrier tape for temporary quarantine, pest monitoring and product protection. Effective against crawling insect pests. It acts as a barrier tape which isolates suspected and infested product. It is a chemical free protection ideal for food storage, production and handling areas. There are 18 metres on every roll, with a width of 30 cm. Thanks to red stripes, it is clearly visible to operators. It can be easily cut to desired length and shape.

Ideal for use as a temporary monitor trap and entry barrier; specific pheromones can also be positioned directly on the glue. It is a poison free product and can be safely used in food industries.

#### TECHNICAL DATA

Length: 18 m  
Width: 300 mm



Code:	Pack:	Carton:
HPRFLY008	1 pc / pack	---



# INSECT CONTROL

## BAIT STATIONS CRAWLING INSECTS

### A BAIT STATION FOR COCKROACHES

Special plastic container designed to hold cockroach insecticide gel.

The bait station has a fixing adhesive on the base. It can safely be used anywhere - on floors, counters, shelves, etc. of public and private buildings as well as in food companies and in HACCP-regulated environments.

It has a hole on the top so that operators can insert the gel with a bait gun without the risk of leakage. Once the gel has been inserted, the trap is activated by simply twisting the upper part so that the slits open and the cockroaches can enter.

#### TECHNICAL DATA

Material: Plastic  
Colour: White  
Dimensions: 60 x 60 x h 20 mm

Code:	Pack:	Carton:
HPRDVD001	20 pcs / pack	120 pcs / carton



### B BAIT STATION FOR ANTS

Special plastic container designed to hold ant gel insecticide.

The bait station has a fixing adhesive on the base. It can safely be used anywhere - on floors, counters, shelves, etc. of public and private buildings as well as in food companies and in HACCP-regulated environments.

It has a hole on the top so that operators can insert the gel with a bait gun without the risk of leakage. Once the gel has been inserted, the trap is activated by simply twisting the upper part so that the slits open and the ants can enter.

#### TECHNICAL DATA

Material: Plastic  
Colour: Green  
Dimensions: 60 x 60 x h 20 mm

Code:	Pack:	Carton:
HPRDVD005	20 pcs / pack	120 pcs / carton





ECOBIRDS:  
LEADING BRAND  
IN BIRD CONTROL



**PICTURE COLLECTION OF BIRD CONTROL INSTALLATIONS**



**Download Ecobirds brochures**



ECOBIRDS:  
LEADING BRAND  
IN BIRD CONTROL



**BIRD SPIKES**

ENG



ECOBIRDS:  
LEADING BRAND  
IN BIRD CONTROL



**ELECTRIC LINE**

ENG





ECOBIRDS:  
LEADING BRAND  
IN BIRD CONTROL

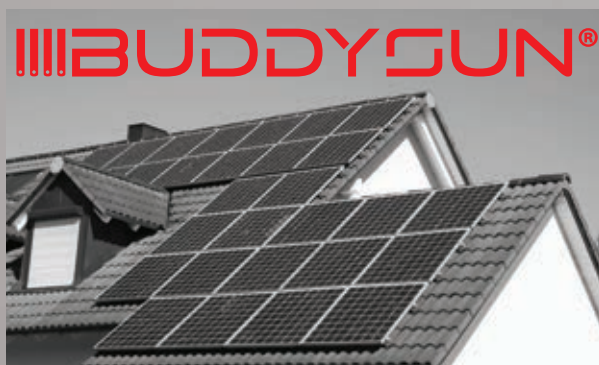

**BIRD NETS**

ENG



**The barrier that protects solar panels**





**The most complete and innovative  
range of multifunctional rodent control  
stations**



**Download Ecorodent line brochure**

# 4INSECTS



**PROFESSIONAL MONITORING AND PEST CONTROL**

**ENG**



**Download 4INSECTS brochure**



# OSD GRUPPO ECOTECH

---



**BUDDYGUN<sup>™</sup>**  
BIRD BARRIER FOR SOLAR PANELS

---



**4 INSECTS**

---



**[www.osdgroup.eu](http://www.osdgroup.eu)**



**[www.ecobirds.com](http://www.ecobirds.com)**



**[www.buddysun.eu](http://www.buddysun.eu)**



**[www.ecorodent.com](http://www.ecorodent.com)**



**[www.4insects.eu](http://www.4insects.eu)**





**OSD GROUP**  
**Campogalliano (MO)**

**OSD GROUP is a company specialized in the design, development and marketing of equipment for pest control.**



**HI-PRO-CHEM**  
**Campogalliano (MO)**

**HI-PRO-CHEM is the leading distributor in Italy of innovative technology for the control and monitoring of pests in the food industry.**



**FERBI**  
**Mosciano S. Angelo (TE)**

**FERBI, a wholly owned subsidiary of Hi-pro-chem, is a chemical plant specialised in the development and production of biocidal products on behalf of third parties.**



**HASLEY**  
**Modena (MO)**

**HASLEY Plastic Technology is a company specialized in the development of moulds and in the production of exclusive plastic injection products.**



**O.S.D. Group S.r.l.**  
Via Ponte Alto, 10  
41011 Campogalliano, Modena, Italy  
Phone +39 059 526595  
osdgroup.eu

**WEB**  
buddysun.eu  
ecobirds.com  
4insects.eu  
ecorodent.com

**FERBI S.r.l**  
Viale I Maggio - C.da Ripoli  
64023 Mosciano Sant' Angelo, Teramo, Italy  
Phone +39 0858072099  
ferbi.it



**O.S.D. Group S.r.l.**

Via Ponte Alto, 10  
41011 Campogalliano,  
Modena, Italy

Phone +39 059 526595  
+39 059 528288

Fax +39 059 527867  
[www.osdgroup.eu](http://www.osdgroup.eu)